

Comfortable indoor ventilation

Prices 2024 - Zehnder Baltics OÜ

always the best climate



always the best climate

Our mission is to provide a healthy indoor climate with top quality solutions. Living spaces are kept at a comfortable temperature by our radiators and heating & cooling ceilings whereas our ventilation solutions make sure that you can breathe fresh clean air 24/7.

zehnder



Trusted partner

We provide our customers with tailored services from planning to installation of excellent solutions for the best indoor climate since 1895.



Know what's next

Consistent focus on innovation has always been the motor for our business. We strive to provide intelligent solutions for ventilation, heating, and cooling.



Swiss quality and precision

Swiss quality and precision are reflected in all our products. Our design standards create timeless elegance in living spaces for yesterday, today, and tomorrow.



Know why, know how

It is our ongoing mission to share our expertise and know how with our customers by providing expert trainings. Our dedicated Zehnder academies bring indoor climate to life.



Dr. Hans-Peter Zehnder & Milva Inderbitzin-Zehnder

From family business to international company

From a small family-run mechanical workshop in Gränichen, Switzerland, Zehnder grew into a leading international corporation. The company roots are deeply intertwined with the entrepreneurial spirit of the Zehnder family. These are visible in Zehnder's corporate culture, the customer focus, respect, trust, curiosity, and openness.

Your global partner for indoor climate

4.000
employees

16
production
plants

more than
1.400
patents and
registered designs



Decorative radiators

Our decorative radiators do not only make a home feel cozy but have also eye-catching designs.



Comfortable indoor ventilation

Our ventilation systems ensure a healthy indoor climate but operate with high energy efficiency, boost wellbeing, and retain the property value.



Heating and cooling ceilings

Our heating and cooling ceiling systems are energy efficient and versatile to fit multiple environments.



Industrial air cleaning

Our clean air solutions are transforming working environments and improving the performance of businesses everywhere.

Zehnder comfort ventilation Simple. Efficient. Smart.

Ventilation, cooling, heating and dehumidifying - your Zehnder comfort ventilation system can do it all, providing you with comfortable, healthy and energy efficient feel-good climate. The complete system offers all components from a single source. With the comprehensive product range, projects can be carried out in almost every building situation.

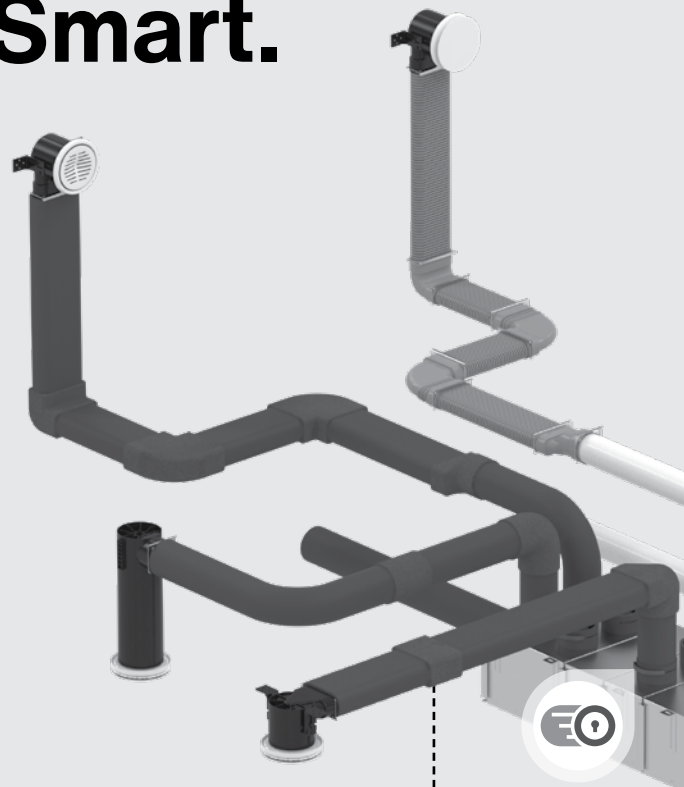

Air distribution system

With the well thought and proven Zehnder air distribution system, you are perfectly prepared for every structural condition.

- Round tube, flat tube or a combination of both
- Simple and time-saving mounting thanks to self explaining components and specially developed molded parts
- Insulated air distribution ComfoTherm for heating and cooling applications
- New connection system RapidLock® for quick and secure mounting



from page 39

Comfort ventilation units



- Decentralised ventilation solutions
- Central comfort ventilation units up to 600 m³/h

from page 9

General Sales and Delivery Conditions:

Our General Sales and Delivery Conditions apply.

You can find these on our website at www.zehnder.ee/terms-of-sale-and-delivery

Filters

Zehnder original filters guarantee best performance, highest possible energy efficiency as well as a hygienic and silent operation of the ventilation unit.

- Filters extract pollen, spores and bacteria out of the fresh outdoor air - ideal for allergy sufferers.

from page 97



Controls & Sensors

- User-friendly operation - from switches to the app
- For an energy saving and demandbased system



from page 37



Connectivity

Smart control your indoor climate with our connectivity solutions:

- Voice control
- Online dashboard with system data
- Integration in BMS systems
- Remote diagnosis and maintenance



Extensions



Cooling, heating and dehumidifying: System extensions for Zehnder ventilation units enhance comfort and energy efficiency.

- **Cooling unit** – Air-to-air heat pump with inverter technology for air pre-treatment.
- **Enthalpy exchanger** – regulation of humidity

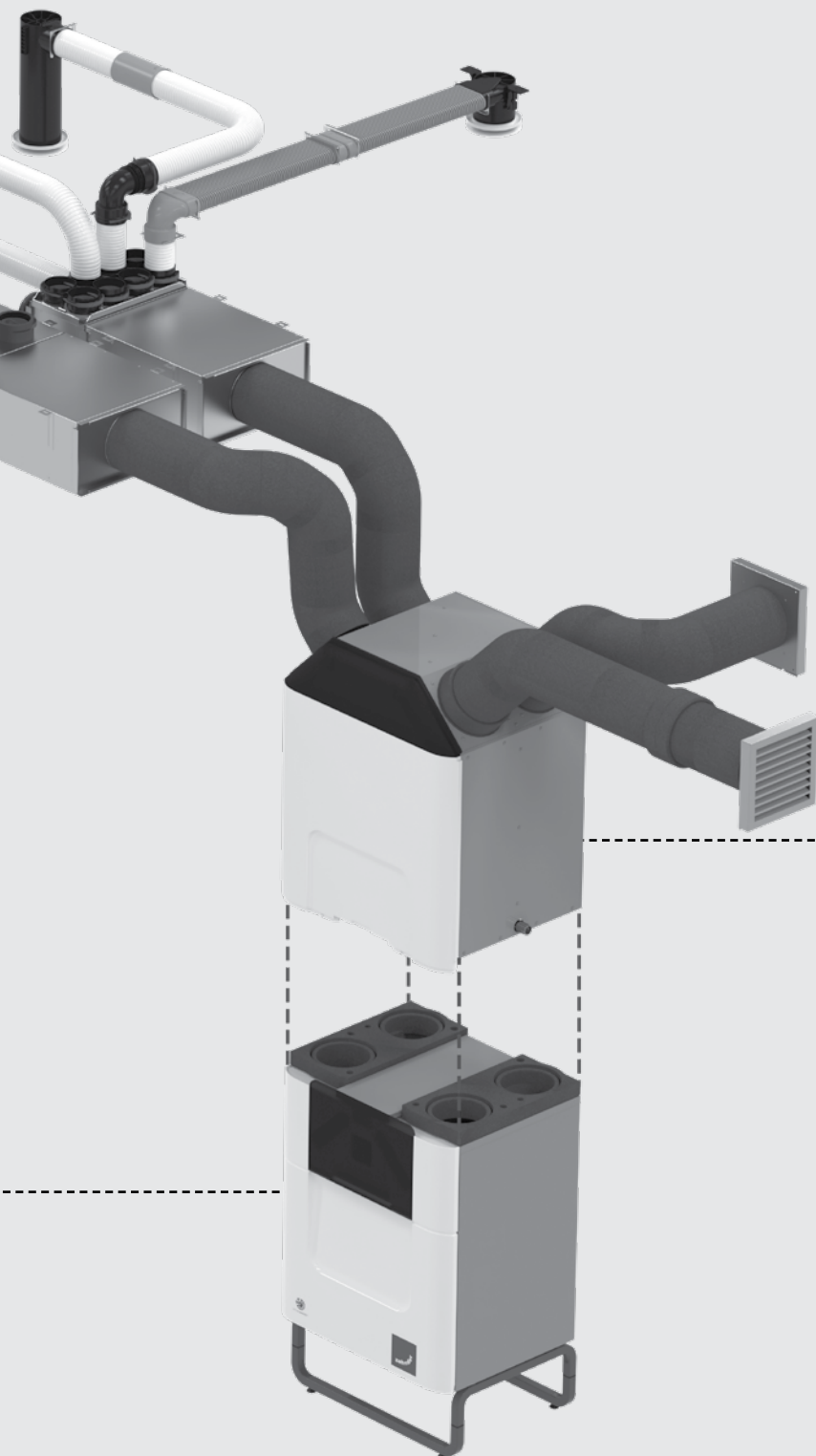



Zehnder comfort ventilation units**Page 12**

Decentralised ventilation solutions
Central comfort ventilation units up to 600 m³/h
System expansions

Zehnder air distribution system**Page 39**

Connection accessories for ventilation units
Silencer/manifold system
Ventilation tubes and moulded parts
Air outlets

Zehnder outdoor and exhaust air**Page 85**

Brine-earth heat exchangers
Facade system
Outdoor air/exhaust air connector

Zehnder replacement filters**Page 97**

Replacement filters for ventilation units
and air distribution systems

General Sales and Delivery Conditions:

Our General Sales and Delivery Conditions apply.

You can find these on our website at www.zehnder.ee/terms-of-sale-and-delivery



Zehnder comfort ventilation units

10 – 36

Information on filter standards	10
Information & overview of energy efficiency classes	12
Overview of comfort ventilation units	16
ComfoSpot 50 decentralised comfort ventilation unit	18
ComfoAir 70 decentralised comfort ventilation unit	20
Extract Fans	22
ComfoAir 160 comfort ventilation unit	23
ComfoAir 180 comfort ventilation unit	24
ComfoAir 200 comfort ventilation unit	25
ComfoAir Flex 250 / 350 comfort ventilation unit	27
ComfoAir Q350 TR comfort ventilation unit	29
ComfoAir Q450 TR comfort ventilation unit	29
ComfoAir Q600 ST comfort ventilation unit	30
Climos 200 comfort ventilation unit	32
Focus 200 comfort ventilation unit	33
ComfoClima 24 / 36	34
Enthalpy exchanger	35
Defroster heater, demand control	36

Be sure with Zehnder original filters to the new ISO 16890 air filter standard

Zehnder ventilation units provide rooms with a permanent supply of fresh and healthy air. The original filter in your ventilation system plays an important role here. In order to better evaluate filter performance, the standard that tests filter performance has now been adapted.

The ISO 16890 air filter standard has superseded the previous standard, EN 779, with regard to filter assessment and classification since January 2017 and comes into force in its entirety as of 1 July 2018.



Particle sizes and filter classification according to the new ISO 16890 air filter standard

ISO 16890 at a glance

Realistic assessment of filters

- ISO 16890 replaces the EN779 standard, whereby only a single particle size of 0.4 µm was used to assess filter performance
- Fine dust, such as soot or pollen, however, comes in different sizes, which are often invisible to the naked eye
- ISO 16890 now divides filters into four classes that filter a certain particle span out of the air
- To be assigned a category, a filter must separate at least 50% of the respective particle sizes.

New name – same high performance

With Zehnder, you can make the perfect choice for an ideal indoor climate every time. High performance is a given when it comes to the development of our original filters. Due to the perfect coordination of the ventilation system and the original filter, the required standards had already been met even before the introduction of the new ISO 16890 air filter standard. So essentially only the name of our filters has changed – but the performance is still the same.

- With the ideal combination of ventilation system and original Zehnder filters, you can be assured.
- This means that our filter set for Zehnder ComfoAir Q, for example, is no longer called F7, but instead ISO ePM1 greater than or equal to 50%.

The energy efficiency label

The energy efficiency marking for comfort ventilation units that was introduced in January 2016 offers you and your customers more information and transparency as well as better guidance with regard to quality and efficiency. For Zehnder, the label signifies a confirmation of the high standards of energy efficiency for products and systems. It also benefits end users going forward, as they continue to choose ventilation units which combine the very best results with maximum functionality.

What is the significance of the energy efficiency label?

At a glance:

- Alphabetic classification in energy efficiency classes from A+ to G
- Parameter for specific energy consumption (SEC): annual power consumption minus annual energy saving
- Most Zehnder units for central comfort ventilation have been classified as A+. Airflow volume, heat and humidity recovery, fans and the control unit all affect the energy efficiency class.



The energy efficiency label

Manufacturer
Zehnder
ComfoAir Q350 TR

Model identifier
471502110

Energy efficiency class
A+ (indicated by a black arrow pointing to the A+ bar)







Sound power level
L_{WA} in dB
41 dB

Maximum airflow volume
in m³/h
350 m³/h

SEC class	SEC in kWh/m²·a
A+ (highest efficiency)	SEC < - 42
A	-42 ≤ SEC < -34
B	-34 ≤ SEC < -26
C	-26 ≤ SEC < -23
D	-23 ≤ SEC < -20
E	-20 ≤ SEC < -10
F	-10 ≤ SEC < 0
G (lowest efficiency)	0 ≤ SEC

A SEC of 0 is equivalent to window ventilation. A SEC of -42 indicates primary energy savings of 42 kWh/m² a.

















Overview of energy efficiency classes¹⁾

Decentralised ventilation unit	Page	Article number	Control according to site requirements			Manual control
			Humidity sensor board 527 007 260	Humidity and VOC sensor board 527 007 270	Humidity and CO ₂ sensor board 527 007 280	
 ComfoSpot 50	18	527 007 210 527 007 220 527 008 580 527 008 770				 ²⁾
 ComfoAir 70	20	527 007 230 527 007 240 527 007 250 527 008 590 527 008 780				

¹⁾ Energy efficiency classes in accordance with Directive 2009/125/EC of EU Regulation no. 1253/2014









²⁾ The control is integrated in the unit

³⁾ Energy efficiency class applies in conjunction with one or two adjoining room connections. If there is no adjoining room connection, energy efficiency class B applies

Overview of energy efficiency classes ¹⁾							
Comfort ventilation unit	Page	Article number	Control according to site requirements			Central demand control	Time control
			2 x CO ₂ sensors 655 000 845 / 655 000 850 / 655 000 855	CO ₂ sensor 655 000 845 / 655 000 850 / 655 000 855	Humidity sensor and Humidity sensor 659 000 330		
 ComfoAir 160	23	471 218 210 471 218 215					
		ComfoAir 160 enthalpy	23	471 218 230 471 218 235			
 ComfoAir 180	24	471 212 210 471 212 215		-		-	
		ComfoAir 180 enthalpy	24	471 212 230 471 212 235	-	-	
 ComfoAir 200	25	471 222 010 471 222 015 471 222 110 471 222 115					
		ComfoAir 200 enthalpy	25	471 222 450 471 222 455 471 222 470 471 222 475			















¹⁾ Energy efficiency classes in accordance with Directive 2009/125/EC of EU Regulation no. 1253/2014

Overview of energy efficiency classes¹⁾

Comfort ventilation unit	Page	Article number	Control according to site requirements		Central demand control	Time control	Manual control
			2 x CO ₂ sensors 655 000 845 / 655 000 850 / 655 000 855	1 x CO ₂ sensor 655 000 845 / 655 000 850 / 655 000 855 and 1 x humidity sensor 659 000 330			
 ComfoAir Flex 250	27	471 234 190		A ⁺	A	A	A
 ComfoAir Flex 350	27	471 234 205		A ⁺	A	A	A
 ComfoAir Q350 TR	29	471 502 110		A ⁺	A ⁺	A	A
 ComfoAir Q350 TR enthalpy	29	471 502 111		A ⁺	A	A	A
 ComfoAir Q450 TR	29	471 502 112		A ⁺	A ⁺	A	A
 ComfoAir Q450 TR enthalpy	29	471 502 113		A ⁺	A	A	A
 ComfoAir Q600 ST	30	471 502 114		A ⁺	A	A	A
 ComfoAir Q600 ST enthalpy	30	471 502 115		A	A	B	B

¹⁾ Energy efficiency classes in accordance with Directive 2009/125/EC of EU Regulation no. 1253/2014

²⁾ Option Box is not combineable with ComfoAir Flex units

Overview of energy efficiency classes ¹⁾								
Comfort ventilation unit	Page	Article number	Control according to site requirements			Central demand control	Time control	Manual control
			2 x CO ₂ sensors 655 000 845 / 655 000 850 / 655 000 855 and expansion set 528 007 290	Humidity sensor 659 000 330 and expansion set 528 007 290	2 x humidity sensors 659 000 330 and expansion set 528 007 290			
 Climos 200 enthalpy	32	527 003 250 527 003 240 527 003 270 527 003 260						
 Focus 200	33	527 002 060 527 002 070						
 Focus 200 enthalpy	33	527 002 080 527 002 090						

¹⁾ Energy efficiency classes in accordance with Directive 2009/125/EC of EU Regulation no. 1253/2014

Overview of comfort ventilation units

	Model	Page	Air volume																			
			50 (m³/h)	100 (m³/h)	150 (m³/h)	200 (m³/h)	250 (m³/h)	300 (m³/h)	350 (m³/h)	400 (m³/h)	450 (m³/h)	500 (m³/h)	550 (m³/h)									
Decentralised	ComfoSpot 50	18	15 - 50																			
	ComfoAir 70	20	15 - 60																			
Centralised	ComfoAir 160	23		32 - 160																		
	ComfoAir 180	24		30 - 180																		
	ComfoAir 200	25		50 - 200																		
	Climos 200	32		50 - 200																		
	Focus 200	33		45 - 200																		
	ComfoAir Flex 250	27		40 - 250																		
	ComfoAir Flex 350	27		40 - 350																		
	ComfoAir Q350 TR	29		40 - 350																		
	ComfoAir Q450 TR	29		50 - 450																		
	ComfoAir Q600 ST	30		60 - 600																		

- Maximum air volume range
- Recommended air volume range for normal ventilation level according to DIN 1946-6

Dimensions / weight				Installation			Nominal connection size	Unit version	
Length (mm)	Height (mm)	Depth (mm)	Weight from (kg)	Wall	Ceiling	Floor-mounted with base	DN / mm	Supply air, left	Supply air, right
380 ¹⁾	376 ¹⁾	50 ¹⁾	6	•					
440 ¹⁾	660 ¹⁾	145 ¹⁾	22	•			90 mm		
670	864	268	30	•	•		DN 125		
558	680	299	22	•			DN 125		
544	1200	324	30	•	•		DN 125		
594	1019	250	25	•	•		DN 125		
752	565	362	25	•		•	DN 125		
960	1110	350	45		•		DN 160		
960	1110	350	45		•		DN 160		
775	850	570	50	•		•	DN 160		
775	850	570	50	•		•	DN 160		
725	850	570	50	•		•	DN 180		









¹⁾ Dimensions of interior wall panel

²⁾ Delivered as right-hand unit; converted to left-hand unit on-site

³⁾ Turn the unit to change it to the left-hand or right-hand version

ODA = outdoor air, ETA = extract air, EHA = exhaust air, SUP = supply air









ComfoSpot decentralised ventilation unit

Product	Description	PU 1	PU 2	Article no.	Gross price €	Discount group
ComfoSpot 50						
  Passive house certified	ComfoSpot 50 comfort ventilation unit 50 m ³ /h airflow volume, cross-counterflow enthalpy exchanger with humidity recovery, for installation in outside wall, with built-in control panel, without wall mounting tube. A wall mounting tube is required for wall installation. As an option, sensor boards for measuring humidity, VOC and CO₂ and/or an external control panel can be installed (accessories) Dimensions: Inside wall panel: 380 x 376 x 50 mm (W x H x D) Outside wall panel: 380 x 376 x 50 mm (W x H x D)					
	ComfoSpot 50 comfort ventilation unit Plastic outside wall panel , without wall mounting tube <i>CSP50-PRM-FRT-PLS</i>	1	9	527 007 210	1.101,90	C
	ComfoSpot 50 comfort ventilation unit Stainless steel outside wall panel , without wall mounting tube <i>CSP50-PRM-FRT-SST</i>	1	9	527 007 220	1.286,80	C
	ComfoSpot 50 comfort ventilation unit 50m ³ /h airflow volume, cross-counterflow enthalpy heat exchanger with humidity recovery, for installation in the outside wall, with built-in humidity sensor board , control panel and plastic outside wall panel, without wall mounting tube. For wall mounting a wall mounting tube is necessary. Optionally an external control panel can be installed (accessory part). <i>CSP50-PRM-RH-FRT-PLS</i>	1	-	527 008 770	1.251,50	C
	ComfoSpot 50 comfort ventilation unit 50m ³ /h airflow volume, cross-counterflow enthalpy heat exchanger with humidity recovery, for installation with window reveal module , with built-in control panel and plastic inside wall panel, without outside wall panel. Optionally sensor boards for humidity, VOC-, CO₂- measuring and/or an external control panel can be installed (accessory parts) <i>CSP50-PRM</i>	1	-	527 008 580	1.061,50	C
	Window reveal module for ComfoSpot 50 consisting of switching unit with solid-state round wall mounting pipe (length= 580 mm) and plugs, 2 flat ducts each à 2040 x 300 mm with seals, 2 flat ducts insulation elements, duct adapter and external wall grille <i>CON-RVL-CSP50</i>	1	-	527 008 660	512,70	C
ComfoSpot 50 accessories						
	ComfoLED control panel for ComfoSpot 50 and ComfoAir 70 Interface made from acrylic glass, for standard cover frame (cut-out 55 x 55 mm) <i>WR-CSP50-CA70-PCK</i>	1	50	527 007 290	106,20	C
	ComfoLED CH control panel for ComfoSpot 50 and ComfoAir 70 Interface made from acrylic glass, with frame (cut-out 55 x 55 mm) <i>WR-CSP50-CA70-CH-PCK</i>	1	-	528 008 830	120,20	C

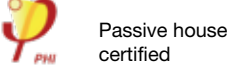
* Energy efficiency class applies in conjunction with one sensor; see overview of energy efficiency classes.







ComfoSpot decentralised ventilation unit						
Product	Description	PU 1	PU 2	Article no.	Gross price €	Discount group
ComfoSpot 50 accessories						
	ComfoRF module for ComfoSpot 50 and ComfoAir 70 Radio frequency module for decentral app-controlling <i>KIT-RF-MOD</i>	1	-	527 010 550	141,60	C
	ConnectBox for ComfoSpot 50 and ComfoAir 70 ConnectBox for decentral app-controlling <i>KIT-CNB</i>	1	-	527 010 580	353,00	C
	Humidity sensor board for ComfoSpot 50 and ComfoAir 70 Sensor board for connection in the unit <i>KIT-SNS-MOD-RH-PCK</i>	1	-	527 007 260	83,60	C
	Humidity and VOC sensor board for ComfoSpot 50 and ComfoAir 70 Sensor board for connection in the unit <i>KIT-SNS-MOD-VOC-PCK</i>	1	-	527 007 270	219,50	C
	Humidity and CO₂ sensor board for ComfoSpot 50 and ComfoAir 70 Sensor board for connection in the unit <i>KIT-SNS-MOD-CO2-PCK</i>	1	-	527 007 280	333,20	C
	Round wall mounting tube made from plastic, Ø 315 mm, with 2 blanking plugs, for retrofitting length = 600 mm <i>MAC-CSP50-PIP-DN315-D600-PLS</i> length = 900 mm <i>MAC-CSP50-PIP-DN315-D900-PLS</i>	1	16	527 005 440	110,20	C
	Square wall mounting tube made from EPP, 360 x 360 (W x H), length = 600 mm, with 2 blanking plugs, for new builds <i>MAC-CSP50-DCT-W360-H360-D600-EPP</i>	1	9	527 005 450	225,60	C
	Extension set for ComfoSpot 50 made of EPP, with 2 plugs, outside diameter 315 mm, length = 285 mm. For wall thickness greater than 600 mm, in combination with round wall mounting tube length = 900 mm <i>SET-EXT-CSP50</i>	1	-	527 009 150	144,30	C
	Filter set for ComfoSpot 50, ISO Coarse ≥ 70 % (G4) 2 pieces <i>FIL-CSP50-CRS/G4-2PC-PCK</i>	1	-	527 005 390	30,60	B
	Filter set for ComfoSpot 50, ISO Coarse ≥ 70 % / ISO ePM10 ≥ 60 % (G4 / F7) 2 pieces <i>FIL-CSP50-CRS/G4-ePM10/F7-2PC-PCK</i>	1	-	527 005 400	33,40	B
	Filter set for ComfoSpot 50, ISO Coarse ≥ 70 % (G4) 10 pieces <i>FIL-CSP50-CRS/G4-10PC-PCK</i>	1	-	527 005 410	115,60	B
	Filter set for ComfoSpot 50, ISO Coarse ≥ 70 % / ISO ePM10 ≥ 60 % (G4 / F7) 10 pieces <i>FIL-CSP50-CRS/G4-ePM10/F7-10PC</i>	1	-	527 005 420	126,80	B

ComfoAir decentralised ventilation unit

Product	Description	PU 1	PU 2	Article no.	Gross price €	Discount group
ComfoAir 70						
  	<p>ComfoAir 70 comfort ventilation unit 60 m³/h (50 Pa) airflow volume, cross-counterflow enthalpy exchanger with humidity recovery, for installation on the inside of outside walls, with connections for ventilation ducts to supply and extract from adjoining rooms, with built-in control panel, without wall mounting tube.</p> <p>Supply connector on rear or side (right) DN 100, Extract air connector on rear or side (left) DN 100</p> <p>As an option, sensor boards for measuring humidity, VOC and CO₂ and/or an external control panel can be installed (accessories)</p> <p>Dimensions: Inside wall panel: 440 x 660 x 145 mm (W x H x D) Outside wall panel: 380 x 376 x 50 mm (W x H x D)</p>					
	<p>ComfoAir 70 comfort ventilation unit Plastic outside wall panel, without wall mounting tube <i>CA70-PRM-FRT-PLS</i></p>	1	4	527 007 240	1.546,50	C
	<p>ComfoAir 70 comfort ventilation unit Stainless steel outside wall panel, without wall mounting tube <i>CA70-PRM-FRT-SST</i></p>	1	4	527 007 250	1.730,30	C
	<p>ComfoAir 70 comfort ventilation unit 60m³/h (50 Pa) airflow volume, cross-counterflow enthalpy heat exchanger with humidity recovery, for installation in the inside of the outside wall, with connections for ventilation ducts to supply and extract adjoining rooms with built-in humidity sensor board, control panel and plastic outside wall panel, without wall mounting tube.</p> <p>Supply connector on rear or side (right) DN 100, Extract Air connector on rear or side (left) DN 100.</p> <p>Optionally an external control panel can be installed (accessory part).</p> <p><i>CA70-PRM-RH-FRT-PLS</i></p>	1	-	527 008 780	1.661,70	C
	<p>ComfoAir 70 comfort ventilation unit 60m³/h (50 Pa) airflow volume, cross-counterflow enthalpy heat exchanger with humidity recovery, for installation with window reveal module, with connections for ventilation ducts to supply and extract adjoining rooms, with built-in control panel and plastic inside wall panel, without outside wall panel and wall mounting tube.</p> <p>Optionally sensor boards for humidity, VOC-, CO₂- measuring and/or an external control panel can be installed (accessory parts)</p> <p><i>CA70-PRM</i></p>	1	-	527 008 590	1.499,40	C
	<p>Window reveal module for ComfoAir 70 consisting of switching unit with solid-state round wall mounting tube (length = 580 mm) and plugs, 2 flat ducts each à 2040 x 300 mm with seals, 4 flat ducts insulation elements, 2 duct adapters and 2 external wall grilles <i>CON-RVL-CA70</i></p>	1	-	527 008 670	512,70	C
ComfoAir 70 accessories						
	<p>ComfoLED control panel for ComfoSpot 50 and ComfoAir 70 Interface made from acrylic glass, for standard cover frame (cut-out 55 x 55 mm) <i>WR-CSP50-CA70-PCK</i></p>	1	-	527 007 290	106,20	C

* Energy efficiency class applies in conjunction with one sensor; see overview of energy efficiency classes.

ComfoAir decentralised ventilation unit						
Product	Description	PU 1	PU 2	Article no.	Gross price €	Discount group
ComfoAir 70 accessories						
	ComfoLED CH control panel for ComfoSpot 50 and ComfoAir 70 Interface made from acrylic glass, with frame (cut-out 55 x 55 mm) <i>WR-CSP50-CA70-CH-PCK</i>	1	-	528 008 830	120,20	C
	ComfoRF module for ComfoSpot 50 and ComfoAir 70 Radio frequency module for decentral app-controlling <i>KIT-RF-MOD</i>	1	-	527 010 550	141,60	C
	ConnectBox for ComfoSpot 50 and ComfoAir 70 ConnectBox for decentral app-controlling <i>KIT-CNB</i>	1	-	527 010 580	353,00	C
	Humidity sensor board for ComfoSpot 50 and ComfoAir 70 Sensor board for connection in the unit <i>KIT-SNS-MOD-RH-PCK</i>	1	-	527 007 260	83,60	C
	Humidity and VOC sensor board for ComfoSpot 50 and ComfoAir 70 Sensor board for connection in the unit <i>KIT-SNS-MOD-VOC-PCK</i>	1	-	527 007 270	219,50	C
	Humidity and CO₂ sensor board for ComfoSpot 50 and ComfoAir 70 Sensor board for connection in the unit <i>KIT-SNS-MOD-CO2-PCK</i>	1	-	527 007 280	333,20	C
	Round wall mounting tube made from plastic, Ø 250 mm, with 2 blanking plugs, for retrofitting length = 600 mm <i>MAC-CA70-PIP-DN250-D600-PLS</i>	1	16	527 005 200	96,40	C
	length = 900 mm <i>MAC-CA70-PIP-DN250-D900-PLS</i>	1	-	527 009 120	118,00	C
	Square wall mounting tube made from EPP, 268 x 268 (W x H), length = 600 mm, with 2 blanking plugs, for new builds <i>MAC-CA70-DCT-W268-H268-D600-EPP</i>	1	6	527 005 800	212,20	C
	Extension set for ComfoAir 70 made of EPP, with 2 plugs, outside diameter 250 mm, length = 285 mm. For wall thickness greater than 600 mm, in combination with round wall mounting tube length = 900 mm <i>SET-EXT-CSP70</i>	1	-	527 009 140	185,70	C
	Filter set for ComfoAir 70, ISO Coarse ≥ 70 % (G4) 2 pieces <i>FIL-CA70-CRS/G4-2PC-PCK</i>	1	-	527 005 180	33,50	B
	Filter set for ComfoAir 70, ISO Coarse ≥ 70 % / ISO ePM10 ≥ 60 % (G4 / F7) 2 pieces <i>FIL-CA70-CRS/G4-ePM10/F7-2PC-PCK</i>	1	-	527 005 190	37,10	B
	Filter set for ComfoAir 70, ISO Coarse ≥ 70 % (G4) 10 pieces <i>FIL-CA70-CRS/G4-10PC</i>	1	-	527 005 160	125,30	B
	Filter set for ComfoAir 70, ISO Coarse ≥ 70 % / ISO ePM10 ≥ 60 % (G4 / F7) 10 pieces <i>FIL-CA70-CRS/G4-ePM10/F7-10PC</i>	1	-	527 005 170	134,70	B
	Sealing tape for ComfoAir 70 1 piece for twin-room connection <i>SEL-PRF-SAD-W9.5-L1000-0049-PCK</i>	1	10	521 000 580	7,70	B

Extract Fans						
Product	Description	PU 1	PU 2	Article no.	Gross price €	Discount group
Zehnder Silent						
	Axial fan					
	SR100 mm basic - in carton	1	-	ZSR100B	66,40	77
	SR100 mm timer - in carton	1	-	ZSR100TR	75,90	77
	SR100 mm humidistat/timer operation - in carton	1	-	ZSR100HTR	91,80	77
	Decorative front covers and inserts Discreet white covers and brackets (10 pcs.)	10	-	ZDECCDIS125	103,70	77
	Shower kit 100 mm shower kit with 12 V SELV light - timer - white and chrome grille	1	-	ZSR100LTSK	144,60	77
Zehnder Samika						
	Adaptive fan 100 mm low watt adaptive fan with SMART humidistat & timer	1	-	ZLE100HT	211,90	77
Zehnder Unity ZCV2						
	Continuously running bathroom and kitchen fan 100 mm mixed flow extract fan with SMART HT which can be applied to all wet rooms including kitchen, bathroom, utility and WCs. With ultra-low energy DC motor, CE marked, CommissionSMART, TimerSMART, IPX5 for walls, IPX4 for ceilings	1	-	ZCV2	253,10	77
Zehnder Unity ZCV3						
 	Low energy continuously running bathroom and kitchen fan 100 mm mixed flow low energy fan, one solution for bathroom, kitchens, utility rooms and WCs. Connect SMART contactless technology for simple set up, customisation and data logging, CE marked, do not disturb technology, SMART Humidity sensing, SMART overrun timer, IPX5 for walls, IPX4 for ceilings	1	-	ZCV3si	289,10	77

ComfoAir ventilation units

Product	Description	PU 1	PU 2	Article no.	Gross price €	Discount group
---------	-------------	------	------	-------------	---------------	----------------

ComfoAir 160

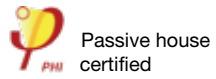

For unit connection options, see page 40

<p>ComfoAir 160 comfort ventilation unit 160 m³/h (100 Pa) airflow volume, cross-counterflow heat exchanger with automatic summer bypass 100%, constant volume regulation, for wall and ceiling installation, without control panel. Dimensions: 670 x 864 x 268 mm (W x H x D) <i>CA160-BS-ND-DE-MCF</i></p>	1	6	471 218 210	3.032,60	C
<p>ComfoAir 160 V comfort ventilation unit 160 m³/h (100 Pa) airflow volume, cross-counterflow heat exchanger with automatic summer bypass 100%, constant volume regulation, with pre-heater, for wall and ceiling installation, without control panel. Dimensions: 670 x 864 x 268 mm (W x H x D) <i>CA160-BS-PRH-ND-DE-MCF</i></p>	1	6	471 218 215	3.487,60	C
<p>ComfoAir 160 enthalpy comfort ventilation unit 160 m³/h (100 Pa) airflow volume, cross-counterflow enthalpy exchanger with humidity recovery and automatic summer bypass 100%, constant volume regulation, for wall and ceiling installation, without control panel. Dimensions: 670 x 864 x 268 mm (W x H x D) <i>CA160-BS-ERV-ND-DE-MCF</i></p>	1	6	471 218 230	3.993,30	C
<p>ComfoAir 160 V enthalpy comfort ventilation unit 160 m³/h (100 Pa) airflow volume, cross-counterflow enthalpy exchanger, with humidity recovery and automatic summer bypass 100%, with pre-heater, constant volume regulation, for wall and ceiling mounting, without control panel. Dimensions: 670 x 864 x 268 mm (W x H x D) <i>CA160-BS-ERV-PRH-ND-DE-MCF</i></p>	1	6	471 218 235	4.446,90	C

ComfoAir 160 accessories





<p>ComfoSense 55 control panel for ComfoAir 160, 180, 200, 350 and 550 suitable for installation into Jung, Gira and Busch-Jaeger switch ranges. Including 2 covers in RAL 9016 and 2 covers in RAL 9001 <i>CU-CFS55-9001/9016</i></p>	1	30	655 010 200	312,90	C
<p>ComfoSense 67 control panel for ComfoAir 160, 180, 200, 350 and 550 Including cover frame, cover and surface-mounted housing in RAL 9016 <i>CU-CFS67-HSG-9016</i></p>	1	30	655 010 215	321,10	C
<p>Remote-controlled control panel as an additional handset for the Sense control panel <i>CU-RF-Z1</i></p>	1	-	655 000 755	137,40	C
<p>Condensate drain accessory for ceiling mounting <i>COD-CA160</i></p>	1	-	990 202 050	104,20	B
<p>Dry siphon set for ComfoAir 160, 180, 200 made from white HDPE plastic, variable wastewater connection, closed on suction side <i>SIP-CA160/180/200</i></p>	1	20	990 201 331	105,40	C
<p>Filter set for ComfoAir 160, ISO Coarse ≥ 65 % (G4) 2 pieces <i>FIL-CA160-SET-CRS/CRS</i></p>	1	-	400 100 023	43,40	B
<p>Filter set for ComfoAir 160, ISO Coarse ≥ 65 % / ISO ePM1 ≥ 65 % (G4 / F7) 2 pieces <i>FIL-CA160-SET-CRS/ePM1</i></p>	1	-	400 100 024	46,10	B

* Energy efficiency class applies in conjunction with two sensors; see overview of energy efficiency classes.
** Energy efficiency class applies in conjunction with one sensor; see overview of energy efficiency classes.





ComfoAir ventilation units

Product	Description	PU 1	PU 2	Article no.	Gross price €	Discount group
---------	-------------	------	------	-------------	---------------	----------------

ComfoAir 180



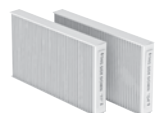

  <p>Passive house certified</p> <p>Unit can also be combined with standard Zehnder components.</p>	ComfoAir 180 comfort ventilation unit 180 m³/h (170 Pa) airflow volume, cross-counterflow heat exchanger with automatic summer bypass 100%, for wall mounting, including wall plate, four connections upwards, alternative supply air connection downwards, without control panel. Dimensions: 558 x 680 x 299 mm (W x H x D) <i>CA180-ND-DE-MCF</i>	1	6	471 212 210	2.429,60	C
	ComfoAir 180 V comfort ventilation unit 180 m³/h (170 Pa) airflow volume, cross-counterflow heat exchanger with automatic summer bypass 100%, for wall installation, including wall plate, four connectors upwards or supply connector downwards, without control panel, with pre-heater . Dimensions: 558 x 680 x 299 mm (W x H x D) <i>CA180-PRH-ND-DE-MCF</i>	1	6	471 212 215	2.859,10	C
	ComfoAir 180 enthalpy comfort ventilation unit 180 m³/h (170 Pa) airflow volume, cross-counterflow enthalpy exchanger with humidity recovery and automatic summer bypass 100%, for wall mounting, including wall plate, four connections upwards, alternative supply air connection downwards, without control panel. Dimensions: 558 x 680 x 299 mm (W x H x D) <i>CA180-ERV-ND-DE-MCF</i>	1	6	471 212 230	3.717,10	C
	ComfoAir 180 V enthalpy comfort ventilation unit 180 m³/h (170 Pa) airflow volume, cross-counterflow enthalpy exchanger with humidity recovery and automatic summer bypass 100%, for wall installation, including wall plate, four connectors upwards or supply connector downwards, without control panel, with pre-heater . Dimensions: 558 x 680 x 299 mm (W x H x D) <i>CA180-ERV-PRH-ND-DE-MCF</i>	1	6	471 212 235	4.145,30	C

ComfoAir 180 accessories

	ComfoSense 55 control panel for ComfoAir 160, 180, 200, 350 and 550 suitable for installation into Jung, Gira and Busch-Jaeger switch ranges. Including 2 covers in RAL 9016 and 2 covers in RAL 9001 <i>CU-CFS55-9001/9016</i>	1	30	655 010 200	312,90	C
	ComfoSense 67 control panel for ComfoAir 160, 180, 200, 350 and 550 Including cover frame, cover and surface-mounted housing in RAL 9016 <i>CU-CFS67-HSG-9016</i>	1	30	655 010 215	321,10	C
	Remote-controlled control panel as an additional handset for the Sense control panel <i>CU-RF-Z1</i>	1	-	655 000 755	137,40	C
	Dry siphon 5/4" for ComfoAir 180 <i>SIP-5/4"-CA350/550-CF-L</i>	1	-	990 201 330	62,40	C
	Dry siphon set for ComfoAir 160, 180, 200 made from white HDPE plastic, variable wastewater connection, closed on suction side <i>SIP-CA160/180/200</i>	1	20	990 201 331	105,40	C
	Filter set for ComfoAir 180, ISO Coarse ≥ 65 % (G4) 2 pieces <i>FIL-CA180-SET-CRS/CRS</i>	1	-	400 100 090	43,40	B
	Filter set for ComfoAir 180, ISO Coarse ≥ 65 % / ISO ePM1 ≥ 55 % (G4 / F7) 2 pieces <i>FIL-SET-CA180-SET-CRS/EPM1</i>	1	-	400 100 091	46,10	B

* Energy efficiency class applies in conjunction with a time control; see overview of energy efficiency classes.



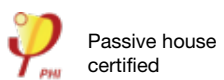

ComfoAir ventilation units						
Product	Description	PU 1	PU 2	Article no.	Gross price €	Discount group
ComfoAir 180 accessories						
	ComfoPipe Plus connection box DN 125 for vertical connection of ComfoAir 180 to ComfoPipe 125, material EPP, with unit connection element	1	8	990 328 804	75,60	C

ComfoAir ventilation units						
Product	Description	PU 1	PU 2	Article no.	Gross price €	Discount group
ComfoAir 200						
	ComfoAir 200 Luxe comfort ventilation unit 200 m³/h (200 Pa) airflow volume, cross-counterflow heat exchanger with automatic summer bypass 100%, for wall and ceiling installation, without control panel. Dimensions: 544 x 1200 x 324 mm (W x H x D)					
	ComfoAir 200 L Luxe with left supply connector <i>CA200-L-LX-ND-EXP-MCF</i>	1	3	471 222 010	3.058,00	C
	ComfoAir 200 R Luxe with right supply connector <i>CA200-R-LX-ND-MCF</i>	1	3	471 222 015	3.058,00	C
	ComfoAir 200 V Luxe comfort ventilation unit 200 m³/h (200 Pa) airflow volume, cross-counterflow heat exchanger with automatic summer bypass 100%, with pre-heater , for wall and ceiling mounting, without control panel. Dimensions: 544 x 1200 x 324 mm (W x H x D)					
	ComfoAir 200 VL Luxe with left supply connector <i>CA200-L-LX-PRH-ND-DE-MCF</i>	1	3	471 222 110	3.520,90	C
	ComfoAir 200 VR Luxe with right supply connector <i>CA200-R-LX-PRH-ND-DE-MCF</i>	1	3	471 222 115	3.520,90	C
	ComfoAir 200 Luxe enthalpy comfort ventilation unit 200 m³/h (200 Pa) airflow volume, cross-counterflow enthalpy exchanger , with humidity recovery and automatic summer bypass 100%, for wall and ceiling mounting, without control panel. Dimensions: 544 x 1200 x 324 mm (W x H x D)					
	ComfoAir 200 L Luxe enthalpy with left supply connector <i>CA200-L-LX-ERV-ND-DE-MCF</i>	1	3	471 222 450	4.484,20	C
	ComfoAir 200 R Luxe enthalpy with right supply connector <i>CA200-R-LX-ERV-ND-DE-MCF</i>	1	3	471 222 455	4.484,20	C
	ComfoAir 200 V Luxe enthalpy comfort ventilation unit 200 m³/h (200 Pa) airflow volume, cross-counterflow enthalpy exchanger , with humidity recovery and automatic summer bypass 100%, with pre-heater , for wall and ceiling mounting, without control panel. Dimensions: 544 x 1200 x 324 mm (W x H x D)					
	ComfoAir 200 VL Luxe enthalpy with left supply connector <i>CA200-L-LX-ERV-PRH-ND-DE-MCF</i>	1	3	471 222 470	4.949,90	C
	ComfoAir 200 VR Luxe enthalpy with right supply connector <i>CA200-R-LX-ERV-PRH-ND-DE-MCF</i>	1	3	471 222 475	4.949,90	C





For unit connection options, see page 40

* Energy efficiency class applies in conjunction with two sensors; see overview of energy efficiency classes.
 **Energy efficiency class applies in conjunction with one sensor; see overview of energy efficiency classes.













ComfoAir ventilation units						
Product	Description	PU 1	PU 2	Article no.	Gross price €	Discount group
ComfoAir 200 accessories						
	ComfoSense 55 control panel for ComfoAir 160, 180, 200, 350 and 550 suitable for installation into Jung, Gira and Busch-Jaeger switch ranges. Including 2 covers in RAL 9016 and 2 covers in RAL 9001 <i>CU-CFS55-9001/9016</i>	1	30	655 010 200	312,90	C
	ComfoSense 67 control panel for ComfoAir 160, 180, 200, 350 and 550 Including cover frame, cover and surface-mounted housing in RAL 9016 <i>CU-CFS67-HSG-9016</i>	1	30	655 010 215	321,10	C
	Remote-controlled control panel as an additional handset for the Sense control panel <i>CU-RF-Z1</i>	1	-	655 000 755	137,40	C
	Dry siphon set for ComfoAir 160, 180, 200 made from white HDPE plastic, variable wastewater connection, closed on suction side <i>SIP-CA160/180/200</i>	1	20	990 201 331	105,40	C
	Filter set for ComfoAir 200, ISO Coarse ≥ 65 % (G4) 2 pieces <i>FIL-PFR-L292-W24-H150-CRS-2pc</i>	1	-	400 100 014	43,40	B
	Filter set for ComfoAir 200, ISO Coarse ≥ 65 % / ISO ePM1 ≥ 55 % (G4 / F7) 2 pieces <i>FIL-PFR-L292-W24-H150-SET-CRS/ePM1</i>	1	-	400 100 013	46,10	B





ComfoAir ventilation units

Product	Description	PU 1	PU 2	Article no.	Gross price €	Discount group
ComfoAir Flex						
	ComfoAir Flex 250 HRV 250 m³/h (200 Pa) air flow volume, cross counterflow heat exchanger, balanced ventilation unit designed for ceiling mounting. 2-in-1 unit (left/right orientation adjustable via software), low power consumption	1	-	A+ 471 234 190	3.520,00	CF
	ComfoAir Flex 250 HRV CAF250-HRV-SI					
 Passive house certified*	ComfoAir Flex 350 HRV 350 m³/h (200 Pa) air flow volume, cross counterflow heat exchanger, balanced ventilation unit designed for ceiling mounting. 2-in-1 unit (left/right orientation adjustable via software), low power consumption	1	-	A+ 471 234 205	3.685,00	CF
	ComfoAir Flex 350 HRV CAF350-HRV-SI					







ComfoAir ventilation units

Product	Description	PU 1	PU 2	Article no.	Gross price €	Discount group
ComfoAir Flex 250/350 accessories						
	ComfoSwitch C55 control panel suitable for installing in Jung, Gira and Busch-Jaeger switch ranges, including 2 covers in RAL 9016 and 2 covers in RAL 9001 <i>SW-CNT55</i>	1	-	655 010 245	144,40	C
	ComfoSwitch C67 control panel incl. cover frame, cover and surface-mounted housing in RAL 9016 <i>SW-CNT67-MAC</i>	1	-	655 010 255	153,90	C
	Remote-controlled control panel as an additional handset for the ComfoSense C control panel <i>CU-RF-Z1</i>	1	-	655 000 755	137,40	C
	CO₂-Sensor C55 55 mm for In-wall installation, suitable with most cover frames (not included), direct connection via ComfoNet <i>SNS-CO2-55C</i>	1	-	655 000 885	260,80	C
	CO₂-Sensor C67 67 mm for In-wall installation, cover frame in scope of delivery, direct connection via ComfoNet <i>SNS-CO2-67C</i>	1	-	655 000 880	260,80	C
	CO₂-Sensor C67 67 mm for On-wall installation, on-wall socket and cover frame in scope of delivery, direct connection via ComfoNet <i>SNS-CO2-67C-MTB</i>	1	-	655 000 875	260,80	C
	ComfoAir RF PCB <i>PCB-RF-CAQ/CAF</i>	1	-	655 011 120	421,80	C
	ComfoAir Flex 250 / 350 pre-heater to increase the outdoor air temperature in winter (heat exchanger frost protection) <i>PRH-CAF-PCK</i>	1	-	400 300 105	610,00	C
	Filter set for ComfoAir Flex 250 / 350, ISO Coarse ≥ 65 % / ISO ePM1 ≥ 65 % (G4 / F7) <i>FIL-CAF-ePM1/CRS</i>	1	-	400 100 121	60,00	C
	Filter set for ComfoAir Flex 250 / 350, ISO Coarse ≥ 65 % (G4), 2 pieces <i>FIL-CAF-CRS-2PC</i>	1	-	400 100 122	56,00	C
	Filter set for ComfoAir Flex 250 / 350, ISO Coarse ≥ 65 % / ISO ePM1 ≥ 65 % (G4 / F7), 5 pieces <i>FIL-CAF-ePM1-CRS-5PC</i>	1	-	400 100 123	278,00	C
	Filter set for ComfoAir Flex 250 / 350, ISO ePM1 ≥ 65 % (F7) 10 pieces <i>FIL-CAF-ePM1-10PC</i>	1	-	400 100 124	307,00	C
	Filter set for ComfoAir Flex 250 / 350, ISO Coarse ≥ 65 % (G4) 10 pieces <i>FIL-CAF-CRS-10PC</i>	1	-	400 100 125	257,00	C

















ComfoAir ventilation units						
Product	Description	PU 1	PU 2	Article no.	Gross price €	Discount group
ComfoAir Q350 TR						
  Passive house certified  DESIGN AWARD 2017 For unit connection options, see page 40	ComfoAir Q350 TR comfort ventilation unit 350 m ³ /h (200 Pa) airflow volume, cross-counterflow heat exchanger with automatic bypass, six integrated sensors to regulate the volume flow, comfort temperature and humidity. Can be used as right or left unit version. For wall mounting, incl. wall plate and integrated display with graphical user interface, pre-heater available as option; see accessories Dimensions: 775 x 850 x 570 (W x H x D)					
	ComfoAir Q350 TR <i>CAQ350-R-SLN-EXP</i>	1	4	471 502 110	3.508,80	CQ
	ComfoAir Q350 TR enthalpy comfort ventilation unit 350 m ³ /h (200 Pa) airflow volume, cross-counterflow enthalpy exchanger with automatic bypass, six integrated sensors to regulate the volume flow, comfort temperature and humidity. Can be used as right or left unit version. For wall mounting, incl. wall plate and integrated display with graphical user interface, pre-heater available as option; see accessories Dimensions: 775 x 850 x 570 (W x H x D)					
	ComfoAir Q350 TR enthalpy <i>CAQ350-R-SLN-ERV-EXP</i>	1	4	471 502 111	4.336,00	CQ

* Energy efficiency class applies in conjunction with two sensors; see overview of energy efficiency classes.







ComfoAir ventilation units						
Product	Description	PU 1	PU 2	Article no.	Gross price €	Discount group
ComfoAir Q450 TR						
  Passive house certified  DESIGN AWARD 2017 For unit connection options, see page 40	ComfoAir Q450 TR comfort ventilation unit 450 m ³ /h (200 Pa) airflow volume, cross-counterflow heat exchanger with automatic bypass, six integrated sensors to regulate the volume flow, comfort temperature and humidity. Can be used as right or left unit version. For wall mounting, incl. wall plate and integrated display with graphical user interface, pre-heater available as option; see accessories Dimensions: 775 x 850 x 570 (W x H x D)					
	ComfoAir Q450 TR <i>CAQ450-SLN-EXP</i>	1	4	471 502 112	4.611,00	CQ
	ComfoAir Q450 TR enthalpy comfort ventilation unit 450 m ³ /h (200 Pa) airflow volume, cross-counterflow enthalpy exchanger with automatic bypass, six integrated sensors to regulate the volume flow, comfort temperature and humidity. Can be used as right or left unit version. For wall mounting, incl. wall plate and integrated display with graphical user interface, pre-heater available as option; see accessories Dimensions: 775 x 850 x 570 (W x H x D)					
	ComfoAir Q450 TR enthalpy <i>CAQ450-SLN-ERV-EXP</i>	1	4	471 502 113	5.436,80	CQ









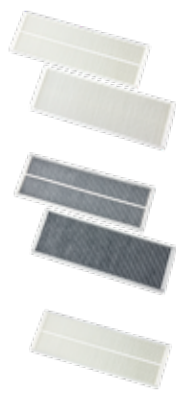

* Energy efficiency class applies in conjunction with two sensors; see overview of energy efficiency classes.

ComfoAir ventilation units



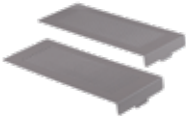









Product	Description	PU 1	PU 2	Article no.	Gross price €	Discount group
ComfoAir Q600 ST						
   For unit connection options, see page 41	ComfoAir Q600 ST comfort ventilation unit 600 m ³ /h (200 Pa) airflow volume, cross-counterflow heat exchanger with automatic bypass, six integrated sensors to regulate the volume flow, comfort temperature and humidity. Can be used as right or left unit version. For wall mounting, incl. wall plate and integrated display with graphical user interface, pre-heater available as option; see accessories Dimensions: 725 x 850 x 570 (W x H x D)					
	ComfoAir Q600 ST <i>CAQ600-ST-EXP</i>	1	4	471 502 114	5.504,80	CQ
	ComfoAir Q600 ST enthalpy comfort ventilation unit 600 m ³ /h (200 Pa) airflow volume, cross-counterflow enthalpy exchanger with automatic bypass, six integrated sensors to regulate the volume flow, comfort temperature and humidity. Can be used as right or left unit version. For wall mounting, incl. wall plate and integrated display with graphical user interface, pre-heater available as option; see accessories Dimensions: 725 x 850 x 570 (W x H x D)					
	ComfoAir Q600 ST enthalpy <i>CAQ600-ST-ERV-EXP</i>	1	4	471 502 115	6.331,90	CQ
Accessories for ComfoAir Q350/450/600						
	ComfoSense C55 control panel for ComfoAir Q350/450/600, suitable for installing in Jung, Gira and Busch-Jaeger switch ranges, including 2 covers in RAL 9016 and 2 covers in RAL 9001 <i>CU-CFSC55</i>	1	-	655 010 225	285,90	C
	ComfoSense C67 control panel for ComfoAir Q350/450/600 incl. cover frame, cover and surface-mounted housing in RAL 9016 <i>CFS-CNT67-MAC</i>	1	-	655 010 235	321,10	C
	ComfoSwitch C55 control panel for ComfoAir Q350/450/600, suitable for installing in Jung, Gira and Busch-Jaeger switch ranges, including 2 covers in RAL 9016 and 2 covers in RAL 9001 <i>SW-CNT55</i>	1	-	655 010 245	144,40	C
	ComfoSwitch C67 control panel for ComfoAir Q350/450/600 incl. cover frame, cover and surface-mounted housing in RAL 9016 <i>SW-CNT67-MAC</i>	1	-	655 010 255	153,90	C
	Remote-controlled control panel as an additional handset for the ComfoSense C control panel <i>CU-RF-Z1</i>	1	-	655 000 755	137,40	C
	CO₂-Sensor C55 , 55 mm for In-wall installation, suitable with most cover frames (not included), direct connection via ComfoNet <i>SNS-CO2-55C</i>	1	-	655 000 885	260,80	C
	CO₂-Sensor C67 , 67 mm for In-wall installation, cover frame in scope of delivery, direct connection via ComfoNet <i>SNS-CO2-67C</i>	1	-	655 000 880	260,80	C
	CO₂-Sensor C67 , 67 mm for On-wall installation, on-wall socket and cover frame in scope of delivery, direct connection via ComfoNet <i>SNS-CO2-67C-MTB</i>	1	-	655 000 875	260,80	C
	CO₂-Sensor V55 , 55 mm for In-wall installation, suitable with most cover frames (not included), 0-10V connection, Option Box required <i>SNS-CO2-V55</i>	1	-	655 000 845	242,60	C
	CO₂-Sensor V67 , 67 mm for In-wall installation, cover frame in scope of delivery, 0-10V connection, Option Box required <i>CO2-SENSOR-0-10V-67</i>	1	-	655 000 850	242,60	C
	CO₂-Sensor V67 , 67 mm for On-wall installation, on-wall socket and cover frame in scope of delivery, 0-10V connection, Option Box required <i>CO2-SENSOR-0-10V-67-ON-WALL</i>	1	-	655 000 855	242,60	C

*Energy efficiency class applies in conjunction with two sensors; see overview of energy efficiency classes.

ComfoAir ventilation units						
Product	Description	PU 1	PU 2	Article no.	Gross price €	Discount group
Accessories for ComfoAir Q350/450/600						
 NEW	Option Box ComfoAir Q350/450/600 for additional connection options for CO ₂ and humidity sensors as well as ComfoFond-L Q. ComfoFond-L Q only: When combined with ComfoFond-L Q, connection cable 400 300 311 needs to be ordered separately. <i>OPB-CAQ-LIGHT VERSION-V2</i>	1	-	471 502 143	179,20	C
 NEW	Connection cable for use of OptionBox combined with ComfoFond-L Q, lenght 2,5 m <i>PSP-CAB-OPB-230V-10A-PCK</i>	1	-	400 300 311	35,50	C
	ComfoConnect LAN C interface for control via app and web portal (the app is called "ComfoControl" and can be downloaded from the AppStore) <i>GWY-LAN-CNT</i>	1	-	655 011 100	304,60	C
	ComfoConnect KNX C interface for KNX connection options <i>GWY-KNX-CNT</i>	1	-	655 011 120	421,80	C
	ComfoAir Q350/450/600 pre-heater to increase the outdoor air temperature in winter (heat exchanger frost protection) <i>PRH-CAQ-PCK</i>	1	-	400 502 007	419,00	C
	ComfoAir Q350/450/600 mounting base Height = 255 mm <i>FRA-CAQ</i>	1	-	471 502 008	189,50	C
	Dry siphon 5/4" for ComfoAir Q350/450/600 <i>SIP-5/4"-CA350/550-CF-L</i>	1	20	990 201 330	62,40	C
	Filter set for ComfoAir Q350/450/600, ISO Coarse ≥ 65 % (G4) 2 pieces <i>FIL-CAQ-CRS-2PC</i>	1	-	400 502 012	50,40	B
	Filter set for ComfoAir Q350/450/600, ISO Coarse ≥ 65 % / ISO ePM1 ≥ 65 % (G4 / F7), 2 pieces <i>FIL-CAQ-ePM1/CRS</i>	1	-	400 502 013	54,50	B
	Filter set for ComfoAir Q350/450/600, ISO Coarse ≥ 65 % / Active coal ePM10, 2 pieces <i>FIL-CAQ-1PC-AC-EPM10-1PC-CRS-PCK</i>	1	-	400 100 097	56,50	B
	Filter set for ComfoAir Q350/450/600, ISO Coarse ≥ 65 % (G4) 10 pieces <i>FIL-CAQ-CRS-10PC</i>	1	-	400 502 014	225,60	B
	Filter set for ComfoAir Q350/450/600, ISO ePM1 ≥ 65 % (F7) 10 pieces <i>FIL-CAQ-ePM1-10PC</i>	1	-	400 502 015	264,20	B





Climos ventilation unit						
Product	Description	PU 1	PU 2	Article no.	Gross price €	Discount group
Climos 200						
  Passive house certified  For unit connection options, see page 41	Climos 200 enthalpy comfort ventilation unit 200 m³/h (100 Pa) airflow volume, cross-counterflow enthalpy exchanger, EC fans with constant volume flow, without condensate connection, for installation suspended from ceiling or wall, or installation in roof pitch, without control panel Dimensions: 594 x 1019 x 250 (W x L x H)			 *		
	Climos 200 L enthalpy with left supply connector (type B) <i>CLI200-ERV-BAS-L</i>	1	4	527 003 250	3.343,50	E
	Climos 200 R enthalpy with right supply connector (type A) <i>CLI200-ERV-BAS-R</i>	1	4	527 003 240	3.343,50	E
	Climos 200 V enthalpy comfort ventilation unit 200 m³/h (100 Pa) airflow volume, cross-counterflow enthalpy exchanger, EC fans with constant volume flow, without condensate connection, with pre-heater , for installation suspended from ceiling or wall, or installation in roof pitch, without control panel Dimensions: 594 x 1019 x 250 (W x L x H)			 *		
	Climos 200 VL enthalpy with left supply connector (type B) <i>CLI200-ERV-COF-PRH-L</i>	1	4	527 003 270	3.846,40	E
	Climos 200 VR enthalpy with right supply connector (type A) <i>CLI200-ERV-COF-PRH-R</i>	1	4	527 003 260	3.846,40	E
Climos 200 accessories						
	TFT RD control panel with colour touch panel for Climos, Focus, Novus For up to 3 ventilation units Colour: Stainless steel (housing) <i>CU-TSS-RDS-PCK</i>	1	20	521 014 140	525,10	C
	LED RD control panel with membrane keyboard for Climos, Focus, Novus, including cover frame Colour: RAL 9010 <i>CU-LED-RDS-PCK</i>	1	20	521 014 130	272,10	C
	Set designer filter cover 2 pieces Colour: RAL 3020 <i>ACC-COV-FIL-CLI200-3020-PCK</i>	1	15	528 007 870	110,70	C
	Filter set for Climos 200, ISO Coarse ≥ 75 % (M5) 2 pieces <i>FIL-CLI200-CRS/M5-2PC-PCK</i>	1	-	527 004 270	49,30	B
	Filter set for Climos 200, ISO Coarse ≥ 75 % / ISO ePM1 60 % (M5 / F7) 2 pieces <i>FIL-CLI200-CRS/M5-ePM1/F7-2PC-PCK</i>	1	-	527 004 280	52,50	B
	Access panel for dry wall installation suitable for Climos 200 <i>COV-SRV-L1300-W700-CLI200</i>	1	15	528 007 930	278,90	B

* Energy efficiency class applies in conjunction with one sensor; see overview of energy efficiency classes.

Focus ventilation unit						
Product	Description	PU 1	PU 2	Article no.	Gross price €	Discount group
Focus 200						
  Passive house certified For unit connection options, see page 41	Focus 200 comfort ventilation unit 200 m ³ /h (150 Pa) airflow volume, cross-counterflow heat exchanger, EC fans with constant volume flow, for installation on wall, incl. mounting rail, without control panel Dimensions: 752 x 565 x 362 mm (W x H x D)					
	Focus 200 L with left supply connector <i>FCS200-L</i>	1	6	527 002 060	2.781,90	E
	Focus 200 R with right supply connector <i>FCS200-R</i>	1	6	527 002 070	2.781,90	E
	Focus 200 enthalpy comfort ventilation unit 200 m ³ /h (150 Pa) airflow volume, cross-counterflow enthalpy exchanger , EC fans with constant volume flow, for installation on wall, incl. mounting rail, without control panel Dimensions: 752 x 565 x 362 mm (W x H x D)					
	Focus 200 L enthalpy with left supply connector <i>FCS200-ERV-L</i>	1	6	527 002 080	3.199,40	E
	Focus 200 R enthalpy with right supply connector <i>FCS200-ERV-R</i>	1	6	527 002 090	3.199,40	E
Focus 200 accessories						
       	TFT RD control panel with colour touch panel for Climos, Focus, Novus For up to 3 ventilation units Colour: Stainless steel (housing) <i>CU-TSS-RDS-PCK</i>	1	-	521 014 140	525,10	C
	LED RD control panel with membrane keyboard for Climos, Focus, Novus, including cover frame Colour: RAL 9010 <i>CU-LED-RDS-PCK</i>	1	-	521 014 130	272,10	C
	Focus summer box module for replacing the heat exchanger for summer ventilation <i>SBX-FCS200</i>	1	30	527 002 940	138,80	B
	Mounting base height-adjustable = 280 mm – 320 mm <i>FRA-FCS200-GAL</i>	1	10	527 002 280	138,80	C
	Dry siphon 5/4" for Focus and Novus <i>SIP-5/4"-CA350/550-CF-L</i>	1	20	990 201 330	62,40	C
	Filter set for Focus 200, ISO Coarse ≥ 70 % (G4) 2 pieces <i>FIL-FCS-CRS/G4-2PC-PCK</i>	1	-	527 004 260	46,10	B
	Filter set for Focus 200, ISO Coarse ≥ 70 % / ISO ePM1 ≥ 60 % (G4 / F7) 2 pieces <i>FIL-FCS-CCP-CRS/G4-ePM1/F7-2PC-PCK</i>	1	-	527 003 430	51,10	B
	Filter set for Focus 200, ISO Coarse ≥ 60 % 10 pieces <i>FIL-FCS-CCP-ePM1/F7-10PC-PCK</i>	1	-	527 009 750	229,10	B

* Energy efficiency class applies in conjunction with two sensors; see overview of energy efficiency classes.







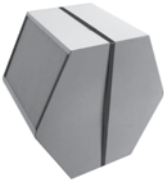



**Energy efficiency class applies in conjunction with a manual control; see overview of energy efficiency classes.

ComfoClime						
Product	Description	PU 1	PU 2	Article no.	Gross price €	Discount group
ComfoClime						
	ComfoClime 24 Air-to-Air heat pump, cooling / heating unit. Suitable for air flows from 200 - 400 m³/h. Combinable with ComfoAir Q 350 and ComfoAir Q 450 Dimensions: 721 x 850 x 575 (W x H x D) <i>ComfoClime 24</i>	1	-	471 420 010	4.382,00	B
	ComfoClime 36 Air-to-Air heat pump, cooling / heating unit. Suitable for air flows from 300 - 600 m³/h. Combinable with ComfoAir Q 450 and ComfoAir Q 600 Dimensions: 721 x 850 x 575 (W x H x D) <i>ComfoClime 36</i>	1	-	471 429 207	4.561,20	B
	ComfoClime Connector for connection of ComfoAir Q 350 & 450 (TR) to ComfoClime <i>CON-CAQ-TR-CC</i>	1	-	990 328 763	159,00	C
	ComfoClime Connector for connection of ComfoAir Q 600 (ST) to ComfoClime <i>CON-CAQ-ST-DN180-CC</i>	1	-	990 328 768	132,50	C



Enthalpy exchanger						
Product	Description	PU 1	PU 2	Article no.	Gross price €	Discount group
Enthalpy exchanger						
 	Enthalpy exchanger for humidity and heat recovery					
	for ComfoAir Q350/450/600 <i>HEX-ERV-370-H500-S-006512-PCK</i>	1	4	400 502 010	1.324,90	B
	for ComfoAir G90/G91/350 <i>HEX-ERV-366-H378-S-002071-PCK</i>	1	-	400 400 013	1.224,80	B
	for ComfoAir 160 <i>HEX-MOD-ERV-G90/CA160</i>	1	-	400 400 037	1.823,70	B
	for ComfoAir 180 <i>HEX-ERV-366-H200-B-003267-PCK</i>	1	-	400 400 039	1.715,80	B
	for ComfoAir 200 <i>HEX-ERV-450-H310-R-002906-PCK</i>	1	-	400 400 017	1.823,70	B
	for ComfoAir 500/550 and Novus 300/450 <i>HEX-ERV-366_H500-S-000254-PCK</i>	1	-	400 400 014	1.473,00	B
for Focus 200 <i>HEX-ERV-366-H265-S-003097-PCK</i>	1	-	527 007 480	672,50	B	

Defroster heater, demand control

Product	Description	PU 1	PU 2	Article no.	Gross price €	Discount group
Defroster heater						
	Iso defroster heater DN 160 with 2000 W PTC heating element including ISO Coarse filter ≥ 70% (G3), without control unit <i>PRH-EPP-DN160-2kW-CRS/G3</i>	1	24	527 001 360	435,00	C
	Iso defroster heater DN 125 with 700 W PTC heating element including ISO Coarse filter ≥ 50% (G3), without control unit <i>PRH-EPP-DN125-700W-CRS/G3</i>	1	40	527 003 450	293,60	C
	Universal thermostat control unit for iso defroster heater including 10 kOhm NTC sensor, cable length 3 m for units with LED control panel <i>UNI-THE-SET-PCK</i>	1	8	521 008 820	378,30	C
	BUS thermostat RD control unit for iso defroster heater including CAT5 cable, 10 kOhm NTC sensor, cable length 3 m for units with TFT control panel <i>BUS-THE-RDS-SET-PCK</i>	1	8	527 004 530	277,60	C
Demand control						
	CO₂-Sensor V55 , 55 mm for In-wall installation, suitable with most cover frames (not included) <i>SNS-CO2-V55</i>	1	-	655 000 845	242,60	C
	CO₂-Sensor V67 , 67 mm for In-wall installation, cover frame in scope of delivery <i>CO2-SENSOR-0-10V-67</i>	1	-	655 000 850	242,60	C
	CO₂-Sensor V67 , 67 mm for On-wall installation, on-wall socket and cover frame in scope of delivery <i>CO2-SENSOR-0-10V-67-ON-WALL</i>	1	-	655 000 855	242,60	C
	CO₂ sensor, on-wall 0 – 10 V control output <i>SNS-CO2-12DC-0/10V-PCK</i>	1	-	528 007 250	596,90	C
	CO₂ sensor, on-wall 0 – 10 V for Climos, Focus and Novus including 12 V UP power supply <i>SNS-CO2-PSP-CCM-230VAC-12DC-PCK</i>	1	10	528 007 280	545,80	C
	Expansion set 0 – 10 V for Climos, Focus and Novus including CO ₂ sensor, on-wall. 12 V UP power supply and maximum value module for detection of maximum value, for up to 6 sensors <i>MVU-SNS-CO2-PSP-CCM-230VAC-12DC-SET-PCK</i>	1	10	528 007 290	617,00	C
	Humidity sensor, on-wall 0 – 10 V control output <i>SNS-RH-SFM</i>	1	-	659 000 330	567,10	C

Connectivity & Controls

Ventilation unit	Type of connection/ Required accessories	Controller
ComfoAir 160	0-10 V direct	CO ₂ Sensor V
ComfoAir 180		
ComfoAir 200		
ComfoAir Q	0-10 V with Option Box	CO ₂ Sensor V
	ComfoConnect LAN C + ComfoNet	ComfoControl App
ComfoAir Flex	ComfoNet	CO ₂ Sensor C
	Peer-to-peer (WiFi)	ComfoControl App



RapidLock
Connection

Click!



Zehnder ComfoFresh air distribution system 40 – 83

Overview of connection components for ventilation units	40
Connection accessories for ventilation units	42
Overview of example combinations with ComfoWell	47
ComfoWell	50
Air distribution manifolds	55
ComfoCube Flex	56
Overview of example combinations with ComfoCube Flex	58
Silencers	61
ComfoTube Therm insulated air distribution system	62
ComfoWell Therm	64
InFloor air distribution	65
OnFloor air distribution	72
Overview of InFloor and OnFloor designer grilles	75
InFloor designer grilles	77
OnFloor designer grilles	80
InFloor and OnFloor designer grilles	81
Service	83



Zehnder RapidLock®
 Quick. Easy. Secure: New connection technology for Zehnder air distribution systems



- Advantages:**
- Strong, secure and air-tight connection combined with easy application
 - Compact design for space saving installation
 - Flexible mounting in every building situation
 - Easy access for cleaning and maintenance





- Function:**
- **Quick and secure** connection of ventilation tubes ComfoTube 75 and 90 through easy insertion even when turned 90°, thanks to the pre-installed clips
 - **Strong connection thanks to smart construction** - RapidLock® prevents unintended loosening of the connection, but allows easy separation for maintenance and cleaning
 - **Air-tight connection avoids unwanted leakage**

The future of air distribution installation
 Discover Zehnder RapidLock®:

- Products with RapidLock® technology:**
- ComfoWell mounting plates (p. 51)
 - Module manifold boxes (p. 55)
 - Grille housing CLD/P & selected components of ComfoTube 70 and 90 air distribution systems (p. 57 ff.)







Overview of connection components for ventilation units				
Ventilation units	ComfoAir 160	ComfoAir 200	ComfoAir Q350 TR	ComfoAir Q450 TR
Connection line				
ComfoPipe Compact flexible duct 				
Aluminium lined flexible duct 125 	Direct	Connection nipple DN 125 990 326 330		
Aluminium lined flexible duct 160 			Connection nipple DN 160 990 326 331	Connection nipple DN 160 990 326 331
Aluminium lined flexible duct 200 				
ComfoPipe Compact 125 	ComfoPipe Compact sleeve 990 328 692	Connection nipple DN 125 990 326 330		
ComfoPipe Compact 160 			ComfoPipe Compact sleeve 990 328 695	ComfoPipe Compact sleeve 990 328 695
ComfoPipe Compact 200 				
ComfoPipe Plus 160 			ComfoPipe Plus 160 ComfoAir Q connecting bend 990 328 704	ComfoPipe Plus 160 ComfoAir Q connecting bend 990 328 704
ComfoPipe Plus 200 				

Overview of connection components for ventilation units





ComfoAir Q600 ST 	Climos 200 	Focus 200 	ComfoClima 24 	ComfoClima 36 
			Direct	Direct
	Connection nipple DN 125 990 326 330	Connection nipple DN 125 990 326 330		
Reducer DN 180/200 990 326 352				
	Connection nipple DN 125 990 326 330	Connection nipple DN 125 990 326 330		
			ComfoPipe Compact DN 160 bend 45° 990 328 694	
Direct				ComfoPipe Compact DN 200 bend 45° 990 328 697
ComfoPipe Plus 200 Adapter 990 328 723				

Connection accessories for ventilation units



Product	Description	PU 1	PU 2	Article no.	Gross price €	Discount group
ComfoPipe Plus						
	ComfoPipe Plus tube, complies with the insulation requirements of DIN 1946-6 in the thermal casing up to 60 mm insulation thickness, material EPP and integral plug-in connector DN 160 L = 1000 mm D = 246 / 160 mm <i>TUB-CPP-DN160-L1M</i> DN 200 L = 1000 mm, D = 286 / 200 mm <i>TUB-CPP-DN200-L1M</i>	1	14	990 328 700	66,70	C
		1	11	990 328 720	89,70	C
	ComfoPipe Plus bend, complies with the insulation requirements of DIN 1946-6 in the thermal casing up to 60 mm insulation thickness, material EPP and integral plug-in connector DN 160 bend 45°, D = 246 / 160 mm <i>BEN-CPP-DN160X45</i> DN 200 bend 45°, D = 286 / 200 mm <i>BEN-CPP-DN200X45</i>	1	64	990 328 701	29,00	C
		1	48	990 328 721	47,30	C
	ComfoPipe Plus sleeve, complies with the insulation requirements of DIN 1946-6 in the thermal casing up to 60 mm insulation thickness, material EPP and integral plug-in connector DN 160 D = 277 / 246 mm <i>CON-CPP-DN160-M</i> DN 200 D = 326 / 286 mm <i>CON-CPP-DN200-M</i>	1	144	990 328 702	24,00	C
		1	104	990 328 722	30,50	C
	ComfoPipe Plus connecting bend 160 for ComfoAir Q350/450 TR ventilation unit connector, complies with the insulation requirements of DIN 1946-6 in the thermal casing up to 60 mm insulation thickness, material EPP and integral plug-in connector 2 piece DN 160 bend 45°, D = 246 / 160 mm <i>CON-CAQ350/450-SLN-CPP-DN160-2PC</i>	1	20	990 328 704	59,30	C
	ComfoPipe Plus 200 adapter, complies with the insulation requirements of DIN 1946-6 in the thermal casing up to 60 mm insulation thickness, for mounting ComfoPipe Plus to ComfoAir Q 600, material EPP <i>CON-CA550/CPP-DN200</i>	1	30	990 328 723	68,30	C
ComfoPipe Plus connector set for ComfoFond-L Q						
	ComfoPipe Plus 160 connector set for ComfoFond-L Q TR to ComfoAir Q350/450 TR consisting of junction, adjustable bracket, sleeve and ComfoPipe Plus adapter to ComfoFond-L Q TR <i>CON-CAQ350/450/CF-L-SLN-CPP-DN160-SET</i>	1	-	990 328 750	74,20	C
	ComfoPipe Plus 200 connector set for ComfoFond-L Q ST to ComfoAir Q600 ST consisting of junction and ComfoPipe Plus adapter to ComfoFond-L Q ST <i>CON-CAQ600/CF-L-SLN-CPP-DN200-SET</i>	1	-	990 328 751	83,20	C

Connection accessories for ventilation units						
Product	Description	PU 1	PU 2	Article no.	Gross price €	Discount group
ComfoPipe Compact						
	ComfoPipe Compact tube material EPP 125 L = 1000 mm, D = 155 / 125 mm <i>TUB-CPCP-DN125-L1m</i> 160 L = 1000 mm, D = 190 / 160 mm <i>TUB-CPCP-DN160-L1m</i> 200 L = 1000 mm, D = 230 / 200 mm <i>TUB-CPCP-DN200-L1m</i>	1	6	990 328 690	50,90	C
		1	4	990 328 693	48,40	C
		1	3	990 328 696	85,30	C
	ComfoPipe Compact bend material EPP 125 bend 45° tube, D = 155 / 125 mm <i>BEN-CPCP-DN125x45</i> 160 bend 45° tube, D = 190 / 160 mm <i>BEN-CPCP-DN160x45</i> 200 bend 45° tube, D = 230 / 200 mm <i>BEN-CPCP-DN200x45</i>	1	28	990 328 691	22,00	C
		1	18	990 328 694	18,70	C
		1	14	990 328 697	31,90	C
	ComfoPipe Compact sleeve 125 D = 179 / 155 mm <i>CON-CPCP-DN125-M</i> 160 D = 214 / 190 mm <i>CON-CPCP-DN160-M</i> 200 D = 254 / 230 mm <i>CON-CPCP-DN200-M</i>	1	40	990 328 692	20,40	C
		1	48	990 328 695	20,10	C
		1	40	990 328 698	22,60	C
	ComfoPipe Compact double socket 125 D = 185 / 155 mm <i>CON-CPCP-DN125-M/M</i> 160 D = 220 / 190 mm <i>CON-CPCP-DN160-M/M</i> 200 D = 260 / 230 mm <i>CON-CPCP-DN200-M/M</i>	1	40	990 328 760	20,00	C
		1	48	990 328 761	19,90	C
		1	40	990 328 762	24,20	C
	ComfoPipe junction 180 mm to 160 mm, material galvanised steel, with seal <i>TRA-SEL-CP-DN180/160</i>	1	20	990 328 664	29,90	C
	ComfoPipe Compact junction 200 mm to 180 mm, junction to connect ComfoFond-L Q ST to ComfoPipe Compact DN 200 <i>TRA-CPP-DN200/180</i>	1	20	990 326 341	34,10	C
	Reducer, with seal DN 160/125 <i>TRA-SEL-DN160/125-N</i>	1	-	990 326 336	21,60	C
	DN 160/150 <i>TRA-SEL-DN160/150-N</i>	1	60	990 326 346	23,90	C
	DN 180/160 <i>TRA-SEL-DN180/160-N</i>	1	50	990 326 337	24,50	C
	DN 200/180 <i>TRA-SEL-DN180/200-N</i>	1	30	990 326 352	29,00	C

Connection accessories for ventilation units

Product	Description	PU 1	PU 2	Article no.	Gross price €	Discount group
Connection accessories						
	Y piece 45° designation DN entry/straight/branch, with seal DN 125/125/125 <i>YPI-SEL-DN125/125/125x45</i> DN 160/160/160 <i>YPI-SEL-DN160/160/160x45</i> DN 200/200/200 <i>YPI-SEL-DN200/200/200x45</i>	1	50	990 326 300	58,20	C
		1	20	990 326 301	85,20	C
		1	8	990 326 316	155,90	C
	Connection nipple for connecting aluminium lined flexible duct/ComfoPipe to roof housing or unit connector, with seal DN 125 <i>CON-SEL-DN125-N</i> DN 160 <i>CON-SEL-DN160-N</i> DN 200 <i>CON-SEL-DN200-N</i>	1	500	990 326 330	10,10	C
		1	250	990 326 331	10,60	C
		1	40	990 326 339	13,70	C
	Straight connector DN 125 <i>CON-DN125-M</i> DN 160 <i>CON-DN160-M</i> DN 200 <i>CON-DN200-M</i>	1	-	990 326 333	10,10	C
		1	-	990 326 334	10,60	C
		1	-	990 326 340	13,70	C
	Reducer, with seal DN 160/125 <i>TRA-SEL-DN160/125-N</i> DN 160/150 <i>TRA-SEL-DN160/150-N</i> DN 200/180 <i>TRA-SEL-DN180/200-N</i>	1	-	990 326 336	21,60	C
		1	60	990 326 346	23,90	C
		1	30	990 326 352	29,00	C

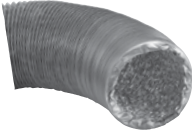
Connection accessories for ventilation units

Product	Description	PU 1	PU 2	Article no.	Gross price €	Discount group
Connection accessories						
	ComfoPipe Compact flexible element for connecting ComfoClime unit with ComfoPipe Compact, black, PU: 1 m					
	DN 160 <i>TUB-FLEX-CON-CPCP-DN160-1m</i>	1	-	990 328 765	99,00	C
	DN 200 <i>TUB-FLEX-CON-CPCP-DN200-1m</i>	1	-	990 328 766	119,00	C
	Aluminium lined flexible duct for connecting ventilation unit to manifold box PU: 10 m					
	DN 125 <i>TUB-DN125-L10m</i>	1	-	990 319 012	111,50	C
	DN 160 <i>TUB-DN160-L10m</i>	1	-	990 319 016	142,80	C
	Aluminium lined flexible duct insulated for exhaust and outdoor air, PU: 6 m					
	DN 125 <i>TUB-ISO-DN125-L6m</i>	1	-	990 319 112	162,80	C
	DN 160 <i>TUB-ISO-DN160-L6m</i>	1	-	990 319 271	194,90	C
	Tube clamp 9 mm wide, diameter 60 – 215 mm, for securing aluminium lined flexible duct, 10 pieces <i>MAC-HOC-W9-DN125/200-10PC</i>	1	100	990 319 321	58,20	C
	ComfoFix Link Tube holder for ComfoPipe DN125, 160 & 200 4pcs PU1 -1 PU2 - 1 <i>MAC-CPCP-CPP-HLD-4PC</i>	1	32	990 327 300	36,70	C

How ComfoFix Link can be applied.

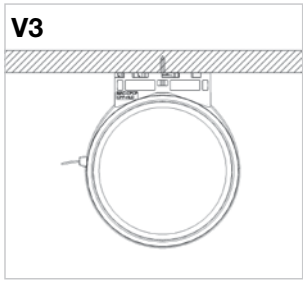
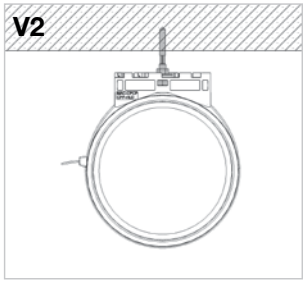
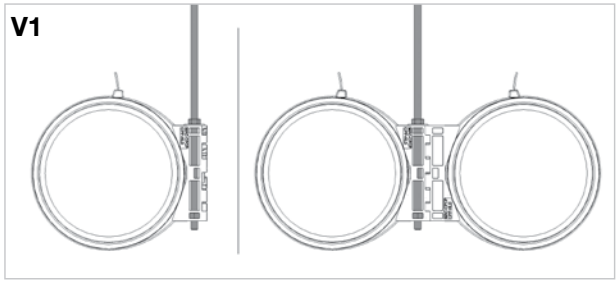

ComfoWell

Zehnder ComfoWell, the modular system for silencers, filters and distribution manifolds.



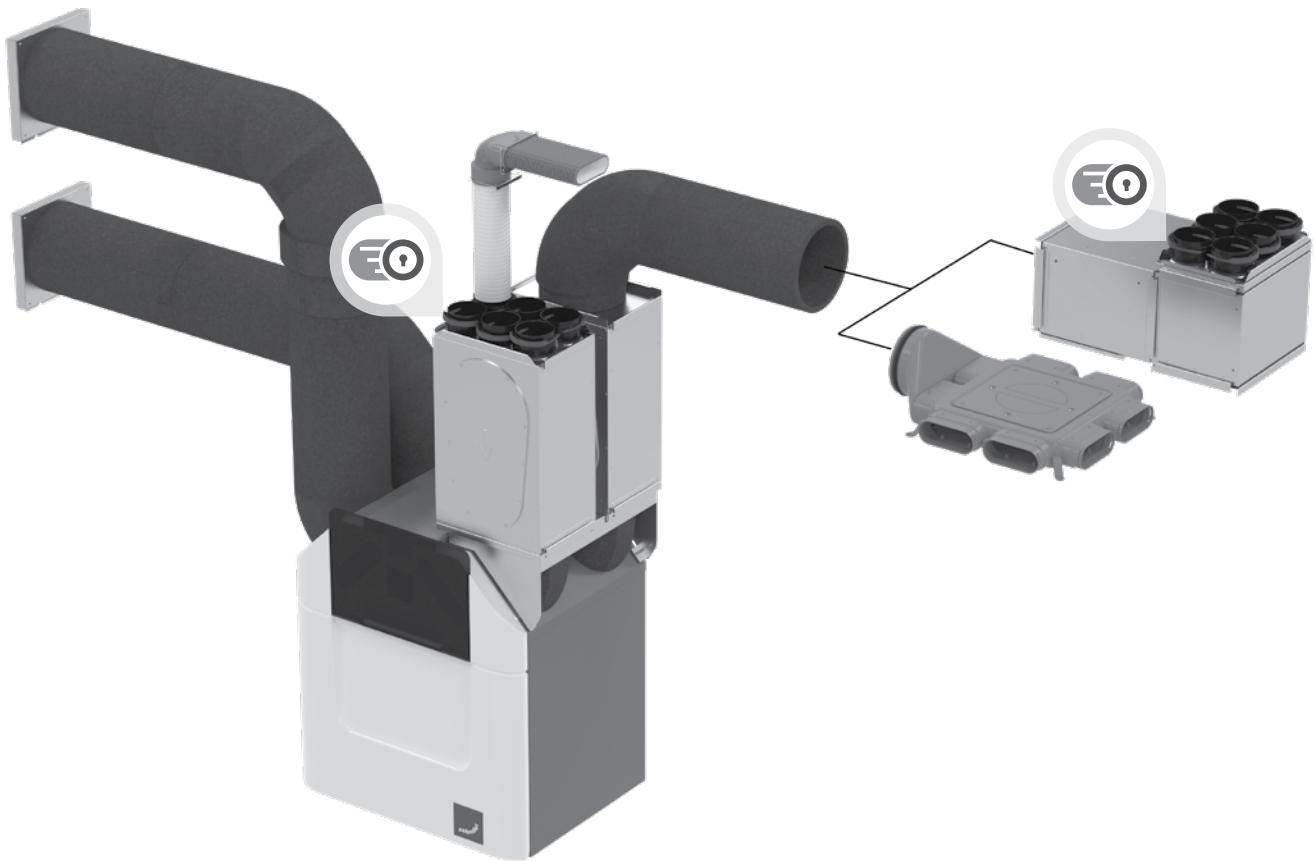

All components within a width can be directly connected to and combined with one another. Components can be used as a duct installation, in combination (e.g. silencer + silencer or silencer + manifold box) or directly on the ventilation unit. For example combinations, see page 47 onwards.

The system consists of five widths:









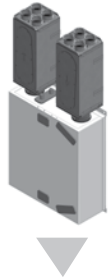

- 220 series for 4 connectors and max. 160 m³/h at a normal ventilation level for ComfoTube 75 or 90
- 320 series for 6 connectors and max. 240 m³/h at a normal ventilation level for ComfoTube 75 or 90
- 420 series for 8 connectors and max. 320 m³/h at a normal ventilation level for ComfoTube 75 or 90
- 520 series for 10 connectors and max. 400 m³/h at a normal ventilation level for ComfoTube 75 or 90
- 625 series for 12 connectors and max. 480 m³/h at a normal ventilation level for ComfoTube 75 or 90







Overview of example combinations with ComfoWell











Combination options	Silencer DN 125	Manifold DN 125 with 6 x ComfoTube 75	Filter housing DN 160, filter F7 or with active carbon filter	Silencer / manifold combination with 6 x ComfoTube 75 connections, DN 125	Silencer / manifold combination with 6 x ComfoTube 75 connections, DN 125
Individual components					
Silencer	1 x Silencer CW-S 320 990 323 501			1 x Silencer CW-S 320 990 323 501	2 x Silencer CW-S 320 990 323 501
Manifold box		1 x Manifold box CW-D 320 990 323 531		1 x Manifold box CW-D 320 990 323 531	
Mounting plate		1 x Mounting plate CW-M 320-6 x 75/P 990 323 612		1 x Mounting plate CW-M 320-6 x 75/P 990 323 612	1 x Mounting plate CW-M 320-6 x 75/P 990 323 612
Filter housing			1 x Filter housing CW-F 320 990 323 551		
Fine dust filter			1 x Fine dust filter CW 320-PM1-75% 990 323 603		
Active carbon filter			1 x Active carbon filter CW-FC 320 990 323 605		
End plate	2 x End plate CW-P 320 DN 125 centric 990 323 511	1 x End plate CW-P 320 DN 125 centric 990 323 511	2 x End plate CW-P 320 DN 160 centric 990 323 512	1 x End plate CW-P 320 DN 125 centric 990 323 511	1 x End plate CW-P 320 DN 125 990 323 511











Overview of example combinations with ComfoWell

<p>Combination options</p> <p>Individual components</p>	<p>Silencer / manifold combination to ComfoAir 160 with 2 x 4 ComfoTube 75 connectors</p> 	<p>Silencer / manifold combination to ComfoAir 200 with 2 x 6 ComfoTube 75 connectors</p> 	<p>Silencer / manifold combination for ComfoAir Q350 TR with 2 x 8 ComfoTube 75 connectors</p> 	<p>Silencer / manifold combination for ComfoAir Q350 TR with 2 x 12 ComfoTube 75 connectors</p> 
<p>Silencer</p> 	<p>2 x Silencer CW-S 220 990 323 500</p>	<p>2 x Silencer CW-S 320 990 323 501</p>	<p>2 x Silencer CW-S 420 990 323 504</p>	<p>2 x Silencer CW-S 625 990 323 505</p>
<p>Mounting plate</p> 	<p>2 x Mounting plate CW-M 220-4 x 75/P 990 323 610</p>	<p>2 x Mounting plate CW-M 320-6 x 75/P 990 323 612</p>	<p>2 x Mounting plate CW-M 420-8 x 75/P 990 323 621</p>	<p>2 x Mounting plate CW-M 625-12 x 75/P 990 323 631</p>
<p>Mounting set</p> 	<p>1 x Mounting set CW-K220 CA 160 990 323 569</p>	<p>1 x Mounting set CW-K320 CA 200 990 323 517</p>	<p>1 x Mounting set CW-K 420 ComfoAir Q350/450 TR 990 323 640</p>	<p>1 x Mounting set CW-K 625 ComfoAir Q350/450 TR 990 323 643</p>
<p>End plate</p> 				
<p>Aluminium lined flexible duct</p> 				
<p>Connection nipple</p> 				







Overview of example combinations with ComfoWell

<p>Silencer / manifold combination for ComfoAir Q450 TR with 2 x 8 ComfoTube 90 connectors</p>	<p>Silencer / manifold combination for ComfoAir Q600 ST with 2 x 12 ComfoTube 90 connectors</p>	<p>Silencer / manifold combination for Focus 200 with 2 x 4 ComfoTube 75 connectors</p>	<p>Silencer / manifold combination for Climos 200 with 2 x 6 ComfoTube 75 connectors</p>	<p>Silencer / manifold combination for Novus 300 with 2 x 10 ComfoTube 75 connectors</p>
				
<p>2 x Silencer CW-S 420 990 323 504</p>	<p>2 x Silencer CW-S 625 990 323 505</p>	<p>2 x Silencer CW-S 220 990 323 500</p>	<p>2 x Silencer CW-S 320 990 323 501</p>	<p>2 x Silencer CW-S 520 990 323 502</p>
<p>2 x Mounting plate CW-M 420-8 x 90/P 990 323 622</p>	<p>2 x Mounting plate CW-M 625-12 x 90/P 990 323 632</p>	<p>2 x Mounting plate CW-M 220-4 x 75/P 990 323 610</p>	<p>2 x Mounting plate CW-M 320-6 x 75/P 990 323 612</p>	<p>2 x Mounting plate CW-M 520-10 x 75/P 990 323 614</p>
<p>1 x Mounting set CW-K 420 ComfoAir Q350/450 TR 990 323 640</p>	<p>1 x Mounting set CW-K 625 ComfoAir Q600 ST 990 323 642</p>			
		<p>2 x End plate CW-P 220-DN125 990 323 510</p>	<p>2 x End plate CW-P 320-DN125 990 323 511</p>	<p>2 x End plate CW-P 520-DN160 990 323 564</p>
		<p>Aluminium lined flexible duct DN125 990 319 012</p>		<p>Aluminium lined flexible duct DN160 990 319 016</p>
		<p>2 x Connection nipple DN 125 990 326 330</p>		<p>2 x Connection nipple DN 160 990 326 331</p>

ComfoWell						
Product	Description	PU 1	PU 2	Article no.	Gross price €	Discount group
    	<p>Silencer without end plates, with highly efficient sound absorption material including clamping rails and fastening material</p> <p>Silencer CW-S 220 dimensions: 500 x 220 x 230 (L x W x D) <i>SIL-CW220</i></p>	1	30	990 323 500	181,50	C
	<p>Silencer CW-S 320 dimensions: 500 x 320 x 230 (L x W x D) <i>SIL-CW320</i></p>	1	20	990 323 501	203,00	C
	<p>Silencer CW-S 420 dimensions: 500 x 420 x 230 (L x W x D) <i>SIL-CW420</i></p>	1	-	990 323 504	237,50	C
	<p>Silencer CW-S 520 dimensions: 500 x 520 x 230 (L x W x D) <i>SIL-CW520</i></p>	1	12	990 323 502	274,80	C
	<p>Silencer CW-S 625 dimensions: 500 x 625 x 230 (L x W x D) <i>SIL-CW625</i></p>	1	10	990 323 505	310,90	C
    	<p>Manifold box without end plates, with sound-absorbing interior lining and inspection plate, for mounting plate, including clamping rails and fastening material</p> <p>Manifold box CW-D 220 dimensions: 230 x 220 x 230 (L x W x D) <i>DIS-CW220-DIV</i></p>	1	32	990 323 530	134,70	C
	<p>Manifold box CW-D 320 dimensions: 230 x 320 x 230 (L x W x D) <i>DIS-CW320-DIV</i></p>	1	28	990 323 531	168,00	C
	<p>Manifold box CW-D 420 dimensions: 230 x 420 x 230 (L x W x D) <i>DIS-CW420-DIV</i></p>	1	-	990 323 620	189,50	C
	<p>Manifold box CW-D 520 dimensions: 230 x 520 x 230 (L x W x D) <i>DIS-CW520-DIV</i></p>	1	28	990 323 532	212,20	C
	<p>Manifold box CW-D 625 dimensions: 230 x 625 x 230 (L x W x D) <i>DIS-CW625-DIV</i></p>	1	-	990 323 630	233,40	C





ComfoWell						
Product	Description	PU 1	PU 2	Article no.	Gross price €	Discount group
	Mounting plate for connecting ComfoTube 75 or 90, suitable for manifold box or silencer, including clamping rails. ComfoTube connector made of plastic with increased tightness and stability.					
	Mounting plate CW-M 220-4 x 75/P dimensions: 220 x 40 x 230 (W x H x D), with Zehnder RapidLock ® <i>MPL-CW220-4DN75-RLC</i>	1	10	990 323 610	67,80	C
	Mounting plate CW-M 220-4 x 90/P dimensions: 220 x 40 x 230 (W x H x D), with Zehnder RapidLock ® <i>MPL-CW220-4DN90-RLC</i>	1	10	990 323 611	76,70	C
	Mounting plate CW-M 320-6 x 75/P dimensions: 320 x 40 x 230 (W x H x D), with Zehnder RapidLock ® <i>MPL-CW320-6DN75-RLC</i>	1	10	990 323 612	86,30	C
	Mounting plate CW-M 320-6 x 90/P dimensions: 320 x 40 x 230 (W x H x D), with Zehnder RapidLock ® <i>MPL-CW320-6DN90-RLC</i>	1	10	990 323 613	94,70	C
	Mounting plate CW-M 420-8 x 75/P dimensions: 420 x 40 x 230 (W x H x D), with Zehnder RapidLock ® <i>MPL-CW420-8DN75-RLC</i>	1	-	990 323 621	103,10	C
	Mounting plate CW-M 420-8 x 90/P dimensions: 420 x 40 x 230 (W x H x D), with Zehnder RapidLock ® <i>MPL-CW420-8DN90-RLC</i>	1	-	990 323 622	120,40	C
	Mounting plate CW-M 520-10 x 75/P dimensions: 520 x 40 x 230 (W x H x D), with Zehnder RapidLock ® <i>MPL-CW520-10DN75-RLC</i>	1	10	990 323 614	120,10	C
	Mounting plate CW-M 520-10 x 90/P dimensions: 520 x 40 x 230 (W x H x D), with Zehnder RapidLock ® <i>MPL-CW520-10DN90-RLC</i>	1	10	990 323 615	146,90	C
	Mounting plate CW-M 625-12 x 75/P dimensions: 625 x 40 x 230 (W x H x D), with Zehnder RapidLock ® <i>MPL-CW625-12DN75-RLC</i>	1	-	990 323 631	137,50	C
	Mounting plate CW-M 625-12 x 90/P dimensions: 625 x 40 x 230 (W x H x D), with Zehnder RapidLock ® <i>MPL-CW625-12DN90-RLC</i>	1	-	990 323 632	170,90	C
	Spacer frame for compensating unevenness when fitting to mounting plate, including securing pins					
	Spacer frame CW-DF 220 with clamping rails and sliding part dimensions: 220 x 24 x 230 (W x H x D) <i>MAC-CW220-FRA-MF</i>	1	10	990 323 537	60,10	C
	Spacer frame CW-DF 320 with clamping rails and sliding part dimensions: 320 x 24 x 230 (W x H x D) <i>MAC-CW320-FRA-MF</i>	1	10	990 323 538	64,20	C
	Spacer frame CW-DF 420 with clamping rails and sliding part dimensions: 436 x 28 x 230 (W x H x D) <i>MAC-CW420-FRA-MF</i>	1	-	990 323 624	66,00	C
	Spacer frame CW-DF 520 with clamping rails and sliding part dimensions: 520 x 24 x 230 (W x H x D) <i>MAC-CW520-FRA-MF</i>	1	10	990 323 539	67,80	C
	Spacer frame CW-DF 625 with clamping rails and sliding part dimensions: 641 x 28 x 230 (W x H x D) <i>MAC-CW625-FRA-MF</i>	1	-	990 323 634	70,20	C

ComfoWell





Product	Description	PU 1	PU 2	Article no.	Gross price €	Discount group
     	Filter housing without filter and end plate, for accommodating one fine dust filter or active carbon filter, including clamping rails and fastening material					
	Filter housing CW-F 220 dimensions: 300 x 220 x 230 (L x W x D) <i>FHO-CW220</i>	1	40	990 323 550	194,90	C
	Filter housing CW-F 320 dimensions: 300 x 320 x 230 (L x W x D) <i>FHO-CW320</i>	1	40	990 323 551	221,50	C
	Filter housing CW-F 420 dimensions: 300 x 420 x 230 (L x W x D) <i>FHO-CW420</i>	1	-	990 323 554	230,90	C
	Filter housing CW-F 520 dimensions: 300 x 520 x 230 (L x W x D) <i>FHO-CW520</i>	1	30	990 323 552	240,20	C
	Filter housing CW-F 625 dimensions: 300 x 625 x 230 (L x W x D) <i>FHO-CW625</i>	1	-	990 323 555	251,00	C
	Fine dust filter CW 220-PM1-90% dimensions: 200 x 225 x 48 (L x W x D), filter ISO ePM1 ≥ 90 % (F9) <i>FIL-CW220-PM1-90%</i>	1	108	990 323 601	57,00	B
	Fine dust filter CW 320-PM1-90% dimensions: 300 x 225 x 48 (L x W x D), filter ISO ePM1 ≥ 90 % (F9) <i>FIL-CW320-PM1-90%</i>	1	72	990 323 604	64,60	B
	Fine dust filter CW 420-PM1-90% dimensions: 2 pieces, each 200 x 225 x 48 (L x W x D), filter ISO ePM1 ≥ 90 % (F9) <i>FIL-CW420-PM1-90%</i>	1	-	990 323 651	84,90	B
	Fine dust filter CW 520-PM1-90% dimensions: 500 x 225 x 48 (L x W x D), filter ISO ePM1 ≥ 90 % (F9) <i>FIL-CW520-PM1-90%</i>	1	48	990 323 607	86,80	B
Fine dust filter CW 625-PM1-90% dimensions: 2 pieces, each 300 x 225 x 48 (L x W x D), filter ISO ePM1 ≥ 90 % (F9) <i>FIL-CW625-PM1-90%</i>	1	-	990 323 654	106,30	B	

ComfoWell						
Product	Description	PU 1	PU 2	Article no.	Gross price €	Discount group
	Active carbon filters for installing in filter housing Active carbon filter CW-FC 220 dimensions: 200 x 225 x 96 (L x W x D) <i>FIL-CW220-AC</i> Active carbon filter CW-FC 320 dimensions: 300 x 225 x 96 (L x W x D) <i>FIL-CW320-AC</i> Active carbon filter CW-FC 420 dimensions: 2 pieces, each 200 x 225 x 96 (L x W x D) <i>FIL-CW420-AC</i> Active carbon filter CW-FC 520 dimensions: 500 x 225 x 96 (L x W x D) <i>FIL-CW520-AC</i> Active carbon filter CW-FC 625 dimensions: 2 pieces, each 300 x 225 x 96 (L x W x D) <i>FIL-CW625-AC</i>	1	54	990 323 602	43,20	B
		1	36	990 323 605	50,20	B
		1	-	990 323 652	61,50	B
		1	24	990 323 608	72,80	B
		1	6	990 323 655	84,40	B
          	Mounting set for direct fitting of ComfoWell components on the ventilation unit Mounting set CW-K 220 – CA 160 dimensions: 220 x 95 x 230 (W x H x D) <i>EPL-CW220-CA160-MAC</i> Mounting set CW-K 320 – CA 160 dimensions: 320 x 95 x 230 (W x H x D) <i>EPL-CW320-CA160-MAC</i> End plate CW-P 220 – DN 125, eccentric for connecting ComfoWell silencer / manifold combination, including clamping rail, suitable for ComfoAir 180 for direct downwards supply connector dimensions: 220 x 443 x 230 mm (L x W x H) <i>EPL-CW220-CA180-MAC</i> Mounting set CW-K 320 – CA 200 dimensions: 320 x 26 x 230 (W x H x D) <i>EPL-CW320-CA200-MAC</i> Mounting set CW-K-320 – ComfoAir Q350/450 TR <i>EPL-CW320-CAQ350/450-SLN-MAC</i> Mounting set CW-K-420 – ComfoAir Q350/450 TR <i>EPL-CW420-CAQ350/450-SLN-MAC</i> Mounting set CW-K-420 – ComfoAir Q600 ST <i>EPL-CW420-CAQ450/600-STT-MAC</i> Mounting set CW-K-520 – ComfoAir Q350/450 TR <i>EPL-CW520-CAQ350/450-SLN-MAC</i> Mounting set CW-K-520 – ComfoAir Q600 ST <i>EPL-CW520-CAQ450/600-STT-MAC</i> Mounting set CW-K-625 – ComfoAir Q350/450 TR <i>EPL-CW625-CAQ350/450-STT-MAC</i> Mounting set CW-K-625 – ComfoAir Q600 ST <i>EPL-CW625-CAQ450/600-STT-MAC</i> Mounting set CW-K 220 – ComfoAir Flex 250/350 <i>EPL-CW220-CAF250/350-EXC-MAC</i> Mounting set CW-K-320 – ComfoAir Flex 250/350 <i>EPL-CW320-CAF250/350-EXC-MAC</i> Mounting set CW-K-420 – ComfoAir Flex 250/350 <i>EPL-CW420-CAF250/350-EXC-MAC</i>	1	-	990 323 569	132,00	C
		1	-	990 323 570	157,40	C
		1	10	990 323 577	51,30	C
		1	10	990 323 517	157,40	C
		1	-	990 323 644	174,90	C
		1	15	990 323 640	178,90	C
		1	-	990 323 641	174,90	C
		1	15	990 323 645	184,20	C
		1	15	990 323 646	178,90	C
		1	15	990 323 643	189,50	C
		1	15	990 323 642	184,20	C
		1	15	990 323 710	101,80	C
		1	15	990 323 711	149,10	C
		1	15	990 323 712	169,30	C

ComfoWell

Product	Description	PU 1	PU 2	Article no.	Gross price €	Discount group
	End plate with connector, centric, including clamping rails					
	End plate CW-P 220 – DN 125 dimensions: 220 x 44.3 x 230 (W x H x D) <i>EPL-CW220-DN125</i>	1	10	990 323 510	51,30	C
	End plate CW-P 320 – DN 125 dimensions: 320 x 44.3 x 230 (W x H x D) <i>EPL-CW320-DN125</i>	1	10	990 323 511	63,90	C
	End plate CW-P 320 – DN 150 dimensions: 320 x 44.3 x 230 (W x H x D) <i>EPL-CW320-DN150</i>	1	10	990 323 562	65,60	C
	End plate CW-P 320 – DN 160 dimensions: 320 x 44.3 x 230 (W x H x D) <i>EPL-CW320-DN160</i>	1	10	990 323 512	65,60	C
	End plate CW-P 420 – DN 150 dimensions: 420 x 44.3 x 230 (W x H x D) <i>EPL-CW420-DN150</i>	1	-	990 323 626	71,00	C
	End plate CW-P 420 – DN 160 dimensions: 420 x 44.3 x 230 (W x H x D) <i>EPL-CW420-DN160</i>	1	10	990 323 627	71,00	C
	End plate CW-P 420 – DN 180 dimensions: 420 x 44.3 x 230 (W x H x D) <i>EPL-CW420-DN180</i>	1	-	990 323 628	75,30	C
	End plate CW-P 420 – DN 200 dimensions: 420 x 44.3 x 230 (W x H x D) <i>EPL-CW420-DN200</i>	1	-	990 323 629	79,80	C
	End plate CW-P 520 – DN 150 dimensions: 520 x 44.3 x 230 (W x H x D) <i>EPL-CW520-DN150</i>	1	10	990 323 568	76,10	C
	End plate CW-P 520 – DN 160 dimensions: 520 x 44.3 x 230 (W x H x D) <i>EPL-CW520-DN160</i>	1	10	990 323 564	76,10	C
	End plate CW-P 520 – DN 200 dimensions: 520 x 44.3 x 230 (W x H x D) <i>EPL-CW520-DN200</i>	1	10	990 323 514	83,80	C
	End plate CW-P 625 – DN 150 dimensions: 625 x 44.3 x 230 (W x H x D) <i>EPL-CW625-DN150</i>	1	-	990 323 636	81,60	C
	End plate CW-P 625 – DN 160 dimensions: 625 x 44.3 x 230 (W x H x D) <i>EPL-CW625-DN160</i>	1	-	990 323 637	81,60	C
	End plate CW-P 625 – DN 180 dimensions: 625 x 44.3 x 230 (W x H x D) <i>EPL-CW625-DN180</i>	1	-	990 323 638	83,10	C
	End plate CW-P 625 – DN 200 dimensions: 625 x 44.3 x 230 (W x H x D) <i>EPL-CW625-DN200</i>	1	-	990 323 639	87,80	C

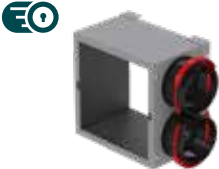
Air distribution manifolds

Product	Description	PU 1	PU 2	Article no.	Gross price €	Discount group
	Module manifold box, 4-port for supply and extract air system with 4 x ComfoTube 90 connectors, including mounting bracket, locking slide and access cover. Connectors and access cover are interchangeable. Powder-coated RAL 7040 version. dimensions (excluding connector): 227.5 x 227.5 x 254 (H x W x L) DN 160 with Zehnder RapidLock ® <i>DIS-DN160-4DN90-RLC</i>	1	20	990 323 061	254,80	C
	Module manifold box, 6-port for supply and extract air system with 6 x ComfoTube 90 connectors, including mounting bracket, locking slide and access cover. Connectors and access cover are interchangeable. Powder-coated RAL 7040 version dimensions (excluding connector): 227.5 x 227.5 x 396 (H x W x L) DN 160 with Zehnder RapidLock ® <i>DIS-DN160-6DN90-RLC</i>	1	20	990 323 062	388,20	C
	Extension module, 2-port for module manifold box with 2 x ComfoTube 90 connectors, including locking slide and angle bracket, with Zehnder RapidLock ® Powder-coated RAL 7040 version <i>DIS-DIV-2DN90-RLC</i>	1	40	990 323 064	130,00	C
	Extension module, 4-port for module manifold box with 4 x ComfoTube 90 connectors, including locking slide and angle bracket, with Zehnder RapidLock ® Powder-coated RAL 7040 version <i>DIS-DIV-4DN90-RLC</i>	1	20	990 323 065	169,70	C

Modular plastic in- and onfloor manifold box Zehnder ComfoCube Flex





Modular plastic in- and onfloor manifold box Zehnder ComfoCube Flex suitable for connection of air ducts for intake and exhaust air up to 300 m³/h.

The manifold box can be assembled from single modules according your needs. The single modules will be connected on-site with clamping strips.











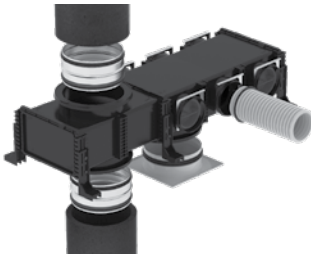
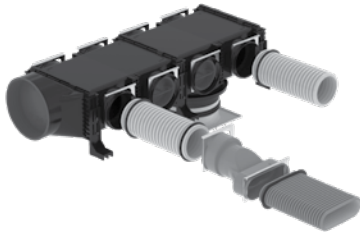



Product	Description	PU 1	PU 2	Article no.	Gross price €	Discount group
Modular plastic in- and onfloor manifold box Zehnder ComfoCube Flex						
	<p>ComfoCube Flex module 4xDN90, incl. 1 set of clamping strips, 1 set of mounting brackets, 1 module sealing, 4 end caps DN90 & 4 fixing sliders</p> <p>Minimum installation depth: 162 mm dimensions: 300 x 284 x 134mm <i>MOD-CCF-2/2+2-DN90-SET</i></p>	1	-	990 323 370	84,00	C
	<p>ComfoCube Flex module 4xDN90 with DN160 connection possibility DN160 connection possible from below or as access area incl. 1 set of clamping strips, 1 set of mounting brackets, 1 module sealing, 4 end caps DN90, 4 fixing sliders & 1 DN160 end cap</p> <p>Minimum installation depth: 162 mm dimensions: 300 x 284 x 134mm <i>MOD-CCF-2/2+2/B-DN90-SET</i></p>	1	-	990 323 371	110,70	C
	<p>ComfoCube Flex module 6xDN90 incl. 1 set of clamping strips, 1 set of mounting brackets, 1 module sealing, 6 end caps DN90 & 6 fixing sliders</p> <p>Minimum installation depth: 162 mm dimensions: 450 x 284 x 134mm <i>MOD-CCF-3/3+3-DN90-SET</i></p>	1	-	990 323 372	92,70	C
	<p>ComfoCube Flex module 6xDN90 with DN160 connection possibility DN160 connection possible from below or as access area incl. 1 set of clamping strips, 1 set of mounting brackets, 1 module sealing, 6 end caps DN90, 6 fixing sliders & 1 DN160 end cap</p> <p>Minimum installation depth: 162 mm dimensions: 450 x 284 x 134mm <i>MOD-CCF-3/3+3/B.O-DN90-SET</i></p>	1	-	990 323 373	119,30	C
	<p>ComfoCube Flex shaft module DN160 for top or bottom connection, incl. 1 set of clamping strips, 1 set of mounting brackets, 1 module sealing & 2 DN160 end caps dimensions: 300 x 284 x 134 mm <i>MOD-CCF-2/0+0/B.B-SET</i></p>	1	-	990 323 374	94,70	C
	<p>ComfoCube Flex frontal connection set DN160 with end plate Outer diameter 160 mm, inner diameter 150mm, incl. 1 set of clamping strips, 1 set of mounting brackets & 1 module sealing Note: Sealing needs to be done via cold shrink film <i>EPL-CCF-L230-W135-H13-SPG-DN160-SET</i></p> <p>Note: Sealing needs to be done with cold shrink film.</p>	1	-	990 323 375	43,30	C
	<p>ComfoCube Flex end plate set for bottom connections incl. 1 set of clamping strips, 1 set of mounting brackets and 1 module sealing <i>EPL-CCF-L230-W135-H13-2PC-SET</i></p>	1	14	990 323 376	41,30	C

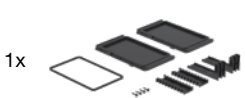
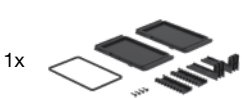

Modular plastic in- and onfloor manifold box Zehnder ComfoCube Flex

Product	Description	PU 1	PU 2	Article no.	Gross price €	Discount group
Accessories						
	Switchover connector DN 90 to ComfoTube 75 for reduction from DN 90 to ComfoTube 75, incl. 2 O-rings and 2 fixing devices, with Zehnder RapidLock ®					
	1 piece TRA-CON-90/75-RLC	1	-	990 322 010	16,00	C
	10 pieces TRA-CON-90/75-RLC-10PC	1	10	990 322 009	110,00	C
	Junction 90 / 75 to flat 51 for connecting to ComfoTube flat 51 and ComfoTube 90 / 75, including 3 O-rings and 3 locking slides. TRA-DN90/75/FL51 Note: for direct connection to the manifold box a 120 mm piece of Zehnder ComfoTube 90 is required.	1	10	990 322 013	17,10	C
	Reducer DN 160 CON-SEL-DN160-N	1	250	990 326 331	10,60	C
	Reducer DN 160/150 TRA-SEL-DN160/150-N	1	60	990 326 346	23,90	C
	Reducer DN 160/125 TRA-SEL-DN160/125-N	1	-	990 326 336	21,60	C

Overview combination examples ComfoCube Flex

 <p>Manifold 10x ComfoTube 75 with bottom connection and bottom access area DN160</p>	 <p>Manifold 6x ComfoTube 90 with riser shaft module DN160 and bottom access area DN160</p>	 <p>Manifold 4x ComfoTube 90 and 4x ComfoTube flat 51 with side connection DN160 and bottom access area DN160</p>
<p>1x</p> 		<p>1x</p> 
		<p>1x</p> 
<p>1x</p> 	<p>1x</p> 	
	<p>1x</p> 	
<p>1x</p> 	<p>1x</p> 	
		<p>1x</p> 
<p>10x</p> 		
		<p>1x</p> 
<p>1x</p> 	<p>2x</p> 	



Silencers						
Product	Description	PU 1	PU 2	Article no.	Gross price €	Discount group
	Flexible silencer					
	DN 125 length excluding connector 1000 mm, flexible <i>SIL-DN125-L1000-FLEX</i>	1	12	990 318 031	100,10	C
	DN 160 length excluding connector 1000 mm, flexible <i>SIL-DN160-L1000-FLEX</i>	1	12	990 318 033	119,80	C
	DN 200 length excluding connector 1000 mm, flexible <i>SIL-DN200-L1000-FLEX</i>	1	12	990 318 035	160,40	C
	For Zehnder ComfoWell silencers, see page 50 onwards					
 	CSI rigid silencer highly efficient, special sound absorption material					
	CSI 350 DN 125 centric dimensions (L x W x D) 700 x 281 x 197 mm <i>SIL-CSI350-DN125/125-L700</i>	1	16	990 318 243	395,00	C
	CSI 350 DN 160 centric dimensions (L x W x D) 700 x 281 x 197 mm <i>SIL-CSI350-DN160/160-L700</i>	1	16	990 318 245	348,20	C
	CSI 550 DN 180 centric, available until 31.12.2024 dimensions (L x W x D) 700 x 350 x 232 mm <i>SIL-CSI550-DN180/180-L700</i>	1	16	990 318 242	807,20	C
	CSI 550 DN 180 eccentric dimensions (L x W x D) 900 x 350 x 232 mm <i>SIL-CSI550-DN180/180-L900-EXC</i>	1	16	990 318 241	807,20	C
CSI 550 DN 200 centric dimensions (L x W x D) 700 x 350 x 230 mm <i>SIL-CSI550-DN200/200-L700</i>	1	20	990 318 251	739,00	C	









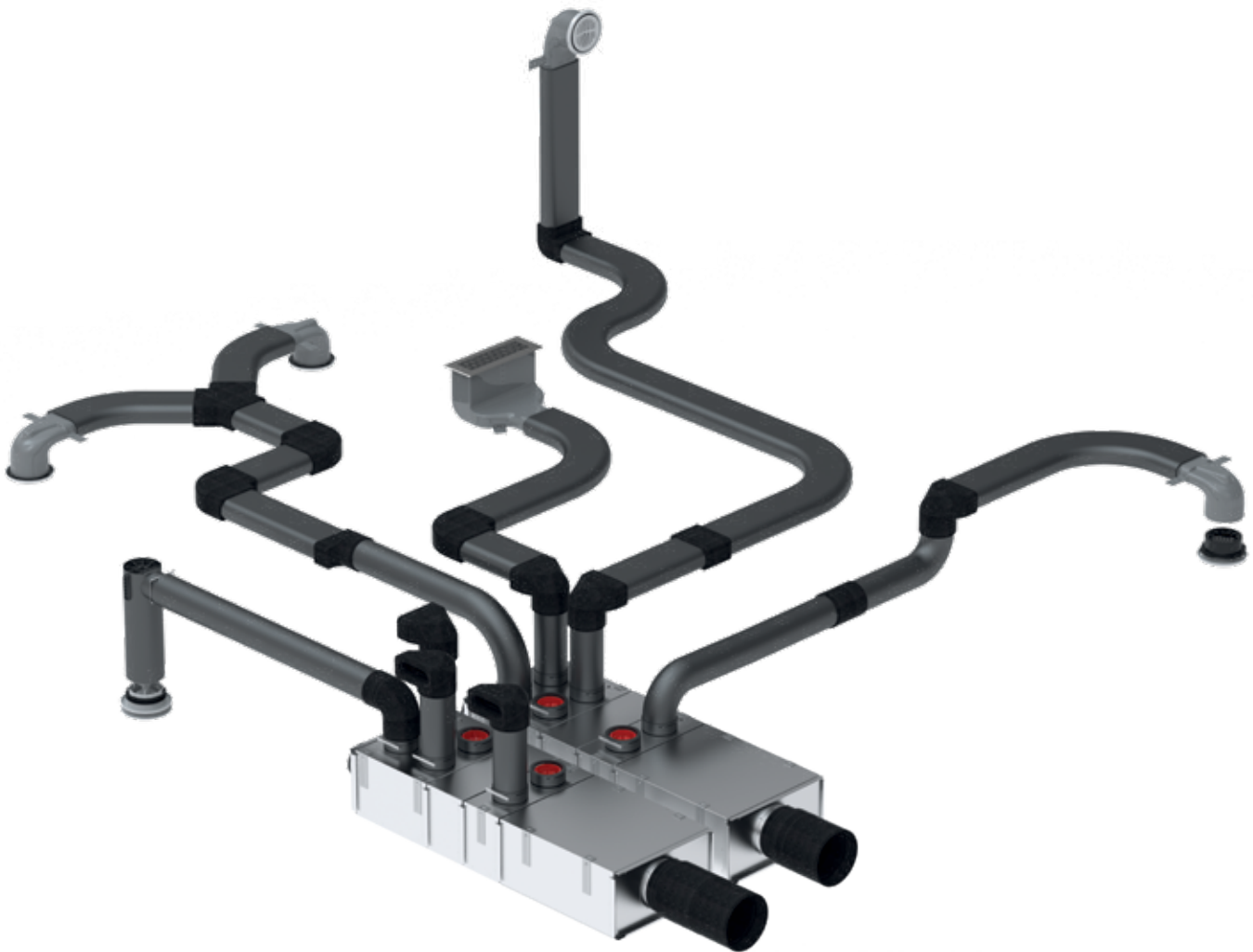



Insulated Air distribution system











ComfoTube Therm

The Zehnder ComfoTube Therm insulated ventilation tube impresses with optimum sound and heat insulation properties for the perfect feel-good climate at home. This makes the ComfoTube Therm the ideal solution for the condensation-free transport of warm and cold air. Thanks to high-quality insulation, the temperature-controlled air is passed through the ventilation tube with almost no temperature loss, so that living spaces can be cooled and heated as required in an energy-efficient manner. The Zehnder ComfoFit Therm insulated connectors, made of expanded polypropylene (EPP), complete the portfolio to form a continuously insulated air distribution system, which is a component of the Zehnder ComfoClima room climate system solution.

















Insulated Air distribution system						
Product	Description	PU 1	PU 2	Article no.	Gross price €	Discount group
ComfoTube Therm						
	ComfoTube Therm 90 Insulated round tube, 20 m roll <i>TUB-CTT-DN90-20m</i>	1	-	990 328 030	529,20	CO
	ComfoTube Therm Flat 51 Insulated flat tube, 10 m roll <i>TUB-CTT-FL51-10m</i>	1	-	990 328 032	367,70	CO
ComfoFit Therm - Connectors						
	ComfoFit Therm connection sleeve 90 <i>CON-CFT-DN90-M</i>	1	-	990 430 855	19,20	CO
	ComfoFit Therm bend 90 <i>BEN-CFT-DN90x90-HOR</i>	1	-	990 430 856	42,30	CO
	ComfoFit Therm sleeve Flat 51 <i>CON-CFT-FL51-M</i>	1	-	990 430 854	24,60	CO
	ComfoFit Therm bend Flat 51, horizontal <i>BEN-CFT-FL51x90-HOR</i>	1	-	990 430 851	31,20	CO
	ComfoFit Therm bend Flat 51, vertical <i>BEN-CFT-FL51x90-VER</i>	1	-	990 430 850	30,50	CO
	ComfoFit Therm Y-piece Flat 51 <i>YPI-CFT-FL51/FL51/FL51</i>	1	-	990 430 853	60,00	CO
	ComfoFit Therm junction 90 to Flat 51 <i>TRA-CFT-FL51/DN90</i>	1	-	990 430 857	33,20	CO
	ComfoFit Therm junction 90 to Flat 51, 90° bend <i>TRA-CFT-FL51/DN90x90</i>	1	-	990 430 852	29,50	CO
	Rubber seal ComfoTube Therm 90 <i>SEL-CT-DN90-10PC</i>	1	100	990 328 363	31,90	C
	End cap ComfoTube Therm 90 <i>CAP-CT-DN90-10PC</i>	1	10	990 328 263	52,90	C

Insulated Air distribution system





Product	Description	PU 1	PU 2	Article no.	Gross price €	Discount group
ComfoWell Therm 420						
	ComfoWell Therm Silencer DN 160 <i>SIL-CWT420-DN160</i>	1	-	990 430 867	459,90	CO
	Comfo Well Therm Silencer DN 200 <i>SIL-CWT420-DN200</i>	1	-	990 430 871	459,90	CO
	ComfoWell Therm extension module 4x90 <i>DIS-CWT420-4DN90</i>	1	-	990 430 860	246,30	CO
	ComfoWell Therm extension module 2x90 <i>DIS-CWT420-2DN90</i>	1	-	990 430 858	174,80	CO
	ComfoWell Therm extension module <i>DIS-CWT420</i>	1	-	990 430 859	131,10	CO
	ComfoWell Therm mounting plate 5x90 <i>MPL-CWT420-5DN90-INS</i>	1	-	990 430 863	179,70	CO
	ComfoWell Therm closed plate <i>EPL-CWT420-BLI</i>	1	-	990 430 861	67,00	CO
	ComfoWell Therm end plate DN 160 <i>EPL-CWT420-DN160-INS</i>	1	-	990 430 862	72,40	CO
	ComfoWell Therm end plate DN 200 <i>EPL-CWT420-DN200-INS</i>	1	-	990 430 870	72,40	CO
	ComfoWell Therm end cap 90 <i>CAP-CWT-DN90-2PC</i>	1	-	990 430 865	8,60	CO

InFloor air distribution

Product	Description	PU 1	PU 2	Article no.	Gross price €	Discount group
	ComfoTube 75 ventilation tube made of special PE, highly flexible, easy to clean, with inner skin, Ø 75 mm					
	20 m TUB-CT-DN75-20m	1	10	990 328 001	110,20	D
	50 m TUB-CT-DN75-50m	1	6	990 328 007	258,70	D
	ComfoTube 90 ventilation tube made of special PE, highly flexible, easy to clean, with inner skin, Ø 90 mm					
	20 m TUB-CT-DN90-20m	1	8	990 328 010	157,60	D
	50 m TUB-CT-DN90-50m	1	5	990 328 009	358,60	D
	Click sleeve for installation-friendly ComfoTube connection					
	Click sleeve DN 75 CON-CT-DN75-M	1	-	990 328 107	9,90	C
	Click sleeve DN 90 CON-CT-DN90-M	1	50	990 328 109	11,10	C
	End cap for ComfoTube to protect against dirt during construction 10 pieces					
	End cap DN 75 CAP-CT-DN75-10PC	1	10	990 328 262	43,00	C
	End cap DN 90 CAP-CT-DN90-10PC	1	10	990 328 263	52,90	C
	O-ring seal for sealing ComfoTube sleeve 10 pieces					
	O-ring seal DN 75 SEL-CT-DN75-10PC	1	100	990 328 362	31,60	C
	O-ring seal DN 90 SEL-CT-DN90-10PC	1	100	990 328 363	31,90	C
	Cable tie 7.5 x 360 mm for fastening ventilation tubes 100 pieces MAC-CT-L365-100PC	1	50	990 327 820	28,50	C
	ComfoTube 75 tube holder for fastening ventilation tubes, with integrated locking and stacking function 10 pieces MAC-DN75-HLD-10PC	1	74	990 327 200	26,00	C
	ComfoTube 90 tube holder for fastening ventilation tubes, with integrated locking and stacking function 10 pieces MAC-DN90-HLD-10PC	1	47	990 327 201	30,10	C

InFloor air distribution						
Product	Description	PU 1	PU 2	Article no.	Gross price €	Discount group
	ComfoTube 90° bend for narrow bends in the ComfoTube pipeline, bend can be shortened and thus used directly in the mounting plate, including 2 locking slides					
	for ComfoTube 75 with Zehnder RapidLock ® <i>BEN-CT-DN75x90-RLC</i>	1	22	990 322 152	23,20	C
	for ComfoTube 90 with Zehnder RapidLock ® <i>BEN-CT-DN90x90-RLC</i>	1	22	990 322 153	27,30	C
	Junction 90 / 75 to flat 51 for connecting to ComfoTube flat 51 and ComfoTube 90 / 75, including 3 O-rings and 3 locking slides <i>TRA-DN90/75/FL51</i>	1	10	990 322 013	17,10	C
	 Junction 90 to flat 51, 90° bend for 90° vertical rerouting, connects to ComfoTube flat 51 and ComfoTube 90, including 2 O-rings and 2 locking slides <i>TRA-FL51/DN90x90</i>	1	20	990 322 046	21,60	C
	ComfoFit junction 2 x 75 to flat 51 to connect to ComfoTube flat 51 and ComfoTube 75, including 3 O-rings and 3 locking slides, with Zehnder RapidLock ® <i>TRA-CT-FL51/2DN75-RLC</i>	1	20	990 322 150	20,90	C
	ComfoTube 75/90 cross-piece for crossing ComfoTube 75/90 <i>TRA-ADJ-4xDN90/75</i>	1	5	990 322 155	54,80	C
	ComfoSet 75 airflow regulator for ComfoTube 75 <i>RES-CT-CS-DN75</i>	1	25	990 320 026	14,60	C
	ComfoSet 90 airflow regulator for ComfoTube 90 <i>RES-CT-CS-DN90</i>	1	25	990 320 027	17,30	C
	5-port connector 90 for airtight connection of 2 x ComfoTube 90 <i>CON-CT-5DN90</i>	1	20	990 326 905	180,30	C



InFloor air distribution						
Product	Description	PU 1	PU 2	Article no.	Gross price €	Discount group
Grille housing TVA-P						
	TVA-P 75 grille housing for connecting valve DN 125 to ComfoTube 2 x DN 75, including guard, mounting bracket, locking slide Connection length = 64 mm <i>OUT-TVA/P-2DN75-Z-DN125-H150-COV-MB</i>	1	12	990 326 121	60,60	C
	For designer grilles, see overview on page 75/76.					
	TVA-P 75 grille housing for connecting valve DN 125 to ComfoTube 2 x DN 75, including guard, mounting bracket, locking slide Connection length = 300 mm <i>OUT-TVA/P-2DN75-Z-DN125-H385-COV-MB</i>	1	10	990 326 125	60,60	C
	For designer grilles, see overview on page 75/76.					
	TVA-P 90 grille housing for connecting valve DN 125 to ComfoTube 1 x DN 90, including guard, mounting bracket, locking slide Connection length = 64 mm <i>OUT-TVA/P-DN90-Z-DN125-H165-COV-MB</i>	1	16	990 326 122	60,60	C
	For designer grilles, see overview on page 75/76.					
	TVA-P 90 grille housing for connecting valve DN 125 to ComfoTube 1 x DN 90, including guard, mounting bracket, locking slide Connection length = 300 mm <i>OUT-TVA/P-DN90-Z-DN125-H400-COV-MB</i>	1	10	990 326 126	60,60	C
	For designer grilles, see overview on page 75/76.					
	TVA-P 90 grille housing for connecting valve DN 125 / design grille to ComfoTube 2 x DN 90, including guard, mounting bracket, locking slide and o-ring Connection length = 300 mm <i>OUT-TVA/P-2DN90-Z-DN125-H400-COV-MB</i>	1	-	990 320 725	71,10	C
	For designer grilles, see overview on page 75/76.					
	TVA-P 90 frontal for connecting valve DN 125 / design grille to ComfoTube 1 x DN 90, including guard, mounting bracket, locking slide Connection length = 160 mm <i>OUT-TVA/P-DN90-DN125-C-COV</i>	1	10	990 326 136	59,80	C
	For designer grilles, see overview on page 75/76.					
	Mounting set DN 125 for securing grille housing to the concrete framework TVA-P 75 (990 326 121) and TVA-P 90 (990 326 122) including attachment nails <i>MAC-TVA/P-DN125-MF-SET</i>	1	-	990 326 127	14,30	C
	Extension 160 mm for TVA-P grille housing and CLRF DN125 <i>EXT-TVA-CLRF-DN125</i>	1	10	990 326 137	38,30	C

InFloor air distribution						
Product	Description	PU 1	PU 2	Article no.	Gross price €	Discount group
Grille housing CLD-P						
	Grille housing CLD-P 75 for connecting to ComfoTube DN 75, including guard, mounting bracket, distance plate and locking slide Height = 85 mm , frontal sleeve <i>OUT-CLD/P-DN75-A-H85-DS-MAC</i>	1	30	990 320 810	125,60	C
	For designer grilles, see overview on page 75/76.					
	Grille housing CLD-P 75 for connecting to ComfoTube DN 75, including guard, mounting bracket, distance plate and locking slide Height = 85 mm , lateral sleeve <i>OUT-CLD/P-DN75-B-H85-DS-MAC</i>	1	24	990 320 811	134,70	C
	Height = 115 mm , lateral sleeve <i>OUT-CLD/P-DN75-B-H115-DS-MAC</i>	1	30	990 320 813	134,70	C
	For designer grilles, see overview on page 75/76.					
	Grille housing CLD-P 90 for connecting to ComfoTube DN 90, including guard, mounting bracket, distance plate and locking slide Height = 115 mm , frontal sleeve <i>OUT-CLD/P-DN90-A-H115-DS-MAC</i>	1	36	990 320 845	134,70	C
	For designer grilles, see overview on page 75/76.					
	Grille housing CLD-P 90 for connecting to ComfoTube DN 90, including guard, mounting bracket, distance plate and locking slide Height = 115 mm , lateral sleeve <i>OUT-CLD/P-DN90-B-H115-DS-MAC</i>	1	30	990 320 846	142,80	C
	Height = 140 mm , lateral sleeve <i>OUT-CLD/P-DN90-B-H140-DS-MAC</i>	1	20	990 320 852	142,80	C
	For designer grilles, see overview on page 75/76.					

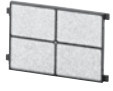
InFloor air distribution

Product	Description	PU 1	PU 2	Article no.	Gross price €	Discount group
	Telescopic frame for floor installation, CLD 60 – 95 mm <i>FRA-DGR-FLO-L260-W160-H60/95</i>	1	40	990 320 370	96,90	C
	90 – 160 mm <i>FRA-DGR-FLO-L260-W160-H90/160</i>	1	40	990 320 371	107,40	C
	155 – 230 mm <i>FRA-DGR-FLO-L260-W160-H155/230</i>	1	40	990 320 373	120,70	C
	Replacement filter for extract air housing CLD 10 pieces <i>FIL-CLD-L158-W113-H9-CRS-45%-10PC-WHITE</i>	1	540	990 320 575	87,30	B





Grille housing CLD-P wide













	Grille housing CLD-P 75 wide for connecting to ComfoTube 3 x DN 75 Height = 115 mm , lateral connectors with Zehnder RapidLock ® <i>OUT-CLD-3DN75-B-RLC-H115</i>	1	70	990 320 533	235,00	C
	For designer grilles, see overview on page 75.					
	Grille housing CLD-P 90 wide for connecting to ComfoTube 2 x DN 90 Height = 115 mm , lateral connectors with Zehnder RapidLock ® <i>OUT-CLD-2DN90-B-RLC-H115</i> Height = 140 mm , lateral connectors with Zehnder RapidLock ® <i>OUT-CLD-2DN90-B-RLC-H140</i>	1	70	988 320 507	214,90	C
	For designer grilles, see overview on page 75.	1	70	988 320 527	214,90	C

Installation accessories for grille housing CLD wide







	Telescopic frame for floor installation CLD wide 60 – 95 mm <i>FRA-DGR-FLO-L430-W160-H60/95</i>	1	-	988 320 370	221,50	C
	155 – 230 mm <i>FRA-DGR-FLO-L430-W160-H155/230</i>	1	-	988 320 369	240,20	C
	Replacement filter for extract air housing CLD, ISO Coarse ≥ 45 % 10 pieces Two filters are required for CLD wide <i>FIL-CLD-L158-W113-H9-CRS-45%-10PC-WHITE</i>	1	540	990 320 575	87,30	B

InFloor air distribution						
Product	Description	PU 1	PU 2	Article no.	Gross price €	Discount group
Inductive vents						
	Slot diffuser ComfoGrid Linea 400 for supply and extract air, wall and ceiling mounting (not suitable for floor mounting), suitable for housing CSB-P 400. Dimensions: 436 x 76,5 mm					
	Model: ComfoGrid Linea 400 Black, glas optics, black <i>DGR-CSB/P-L400-W75-Linea-Black</i>	1	-	990 321 790	240,20	C
	Model: ComfoGrid Linea 400 White, glas optics, white <i>DGR-CSB/P-L400-W75-Linea-White</i>	1	-	990 321 791	240,20	C
	Model: ComfoGrid Linea 400 Inox, stainless steel <i>DGR-CSB/P-L400-W75-Linea-Inox</i>	1	-	990 321 792	197,20	C
	Slot diffuser ComfoGrid Linea 600 for supply and extract air, wall and ceiling mounting (not suitable for floor mounting), suitable for housing CSB-P 600. Dimensions: 636 x 76,5 mm					
	Model: ComfoGrid Linea 600 Black, glas optics, black <i>DGR-CSB/P-L600-W75-Linea-Black</i>	1	-	990 321 793	295,70	C
	Model: ComfoGrid Linea 600 White, glas optics, white <i>DGR-CSB/P-L600-W75-Linea-White</i>	1	-	990 321 794	295,70	C
	Model: ComfoGrid Linea 600 Inox, stainless steel <i>DGR-CSB/P-L600-W75-Linea-Inox</i>	1	-	990 321 795	239,00	C
	Slot diffuser ComfoGrid Lamina for supply and extract air, wall and ceiling mounting (not suitable for floor mounting), adjustable air outlet angle, suitable for housing CSB-P 400 and 600.					
	ComfoGrid Lamina 400 , aluminum, Dimension 436 x 76,5 mm <i>DGR-CSB-L400-W75-Lamina-ALU</i>	1	10	990 321 740	181,20	C
	ComfoGrid Lamina 600 , aluminum, Dimension 636 x 76,5 mm <i>DGR-CSB-L600-W75-Lamina-ALU</i>	1	10	990 321 760	196,90	C
	Slot diffuser ComfoGrid Bilamina for supply and extract air, wall and ceiling mounting (not suitable for floor mounting), double sided air intake for evenly, barely noticeable inflow, suitable for housing CSB-P 400 and 600.					
	ComfoGrid Bilamina 400 , aluminum, Dimension 445 x 83 mm <i>DGR-CSB-L400-W75-Bilamina-ALU</i>	1	10	990 321 640	181,20	C
	ComfoGrid Bilamina 600 , aluminum, Dimension 645 x 83 mm <i>DGR-CSB-L600-W75-Bilamina-ALU</i>	1	10	990 321 660	196,90	C
	ComfoCase CSB-P 400 for slot diffuser ComfoGrid Linea, Lamina and Bilamina, for connection to 2 x round tube Zehnder ComfoTube 75 or 1 x round tube Zehnder ComfoTube 90, wall- and ceiling mounting possible (not suitable for floor mounting), lateral connection. Height = 182 mm <i>OUT-CSB/P-2DN75-DN90-B-L410</i>	1	-	990 321 745	78,90	C
	ComfoCase CSB-P 600 for connection to 2 x round tube Zehnder ComfoTube 90 or 1 x round tube Zehnder ComfoTube 110 (ComfoTube 110 and components on request), wall and ceiling mounting (not suitable for floor mounting), lateral connection. Height = 182 mm <i>OUT-CSB/P-2DN90-DN110-B-L610</i>	1	-	990 321 746	115,90	C

InFloor air distribution						
Product	Description	PU 1	PU 2	Article no.	Gross price €	Discount group
Inductive vents						
	ComfoSet 75 short for housing CSB-P 400 and 600 air flow restricter for ComfoTube 75 <i>RES-CT-CS-DN75-L30</i>	1	25	988 320 030	14,70	C
	ComfoSet 90 short for housing CSB-P 400 and 600 air flow restricter for ComfoTube 90 <i>RES-CT-CS-DN90-L30</i>	1	25	988 320 031	17,50	C
	Mounting bracket for housing CSB-P 400 and 600 for wall mounting and suspended ceilings. Content: 2 pieces <i>MAC-CSB-MB</i>	1	-	988 321 646	60,30	C
	Switchover connector DN 90 to ComfoTube 75 for housing CSB-P 600, for reduction from DN 90 to ComfoTube 75, incl. 2 O-rings and 2 fixing devices, with Zehnder RapidLock ® <i>TRA-CON-90/75-RLC</i>	1	-	990 322 010	16,00	C
	Filter set for housing CSB-P 400 for use in extract air mode, ISO Coarse ePM1 ≥ 55 % (G3), Content: 10 pieces <i>FIL-CSB/P-L410-W55-CRS-55%-10PC</i>	1	-	990 321 768	69,00	B
	Filter set for housing CSB-P 600 for use in extract air mode, ISO Coarse ePM1 ≥ 55 % (G3), Content: 10 pieces <i>FIL-CSB/P-L610-W55-CRS-55%-10PC</i>	1	-	990 321 769	99,90	B
ComfoDuct overflow element						
	ComfoDuct overflow element for air connection between rooms, including sound absorption elements; two designer grilles are required (not included in the scope of delivery)					
	for wall thicknesses of 80 – 140 mm <i>OUT-CD-H80/140</i>	1	18	990 324 052	146,90	C
	for wall thicknesses of 140 – 260 mm <i>OUT-CD-H140/260</i>	1	20	990 324 053	146,90	C
	For designer grilles, see page 75 onwards					

OnFloor air distribution						
Product	Description	PU 1	PU 2	Article no.	Gross price €	Discount group
OnFloor air distribution						
	Twin duct CK 300 for connecting unit distribution manifolds to walls, floors and ceilings, length 1,5 m <i>TUB-CK300-1,5m</i>	1	37	990 322 020	57,60	C
	CK 300 flexible element for flexible connection to twin duct CK 300 including a lip seal. Used as flexible bend (up to 45°) and as height offset for twin duct CK 300 <i>CON-CK300-FLEX</i>	1	12	990 328 821	40,30	C
	CK 300 twin duct nipple for connecting twin duct CK 300, including 4 lip seals <i>CON-CK300-N</i>	1	10	990 322 023	18,20	C
	Twin duct bend CK 300 H for horizontal 90° bend, including 4 lip seals <i>BEN-CK300x90-HOR</i>	1	10	990 322 021	28,30	C
	Twin duct bend CK 300 V for vertical 90° bend, including 4 lip seals <i>BEN-CK300x90-VER</i>	1	10	990 322 022	24,30	C
	Junction CK 300 / DN 160 adapter for twin duct CK 300 to pipe DN 160, including 2 lip seals <i>TRA-DN160/CK300</i>	1	5	990 322 025	42,70	C
	Junction CK 300 / DN 125 adapter for twin duct CK 300 to pipe DN 125, including 2 lip seals <i>TRA-DN125/CK300</i>	1	35	990 322 029	42,70	C
	Twin duct cap CK 300 end cap to protect against dirt during construction, for twin duct CK 300 <i>CAP-CK300</i>	1	136	990 322 024	8,00	C
	Lip seal CK 300 for CK 300 duct, 10 pieces <i>SEL-CK300-10PC</i>	1	10	990 322 026	38,60	C
	flat 51 6-port manifold for supply or extract air system, with 6 ComfoTube flat 51 connectors, including 6 O-rings and 6 locking slides, with access panel <i>DIS-6FL51</i>	1	10	990 322 030	252,20	C
	flat 51 4-port manifold for supply or extract air system, with 4 ComfoTube flat 51 connectors, including 4 O-rings and 4 locking slides, with access panel <i>DIS-4FL51</i>	1	10	990 322 031	158,70	C
	Manifold flat 51, 4-port with single connection, for supply air or extract air with 4 ComfoTube flat 51 connectors, including 4 O-rings and 4 locking slides, with access panel. Suitable for use as left-hand and right-hand version, convertible <i>DIS-4FL51-1CK300</i>	1	50	990 328 823	158,70	C
	Manifold connector DN 160 6-port for flat 6-port manifold directly to pipe DN 160 <i>EPL-6FL51-DN160</i>	1	10	990 322 037	168,00	C
	Stacking frame with cover for 6-port manifold assembly 50 – 80 mm / in floor <i>FRA-DIS-FLO-6FL51-H50/80</i>	1	60	990 322 042	136,20	C
	80 – 130 mm / in floor <i>FRA-DIS-FLO-6FL51-H80-130</i>	1	60	990 322 043	140,10	C
	Stacking frame with cover for 4-port manifold assembly 50 – 80 mm / in floor <i>FRA-DIS-FLO-4FL51-H50/80</i>	1	80	990 322 040	122,20	C

OnFloor air distribution						
Product	Description	PU 1	PU 2	Article no.	Gross price €	Discount group
	ComfoTube flat 51 ventilation tube made from PE easy to clean, with smooth inner skin, 51 x 138 mm					
	20 m <i>TUB-CT-FL51-20m</i>	1	8	990 328 002	326,50	D
	50 m <i>TUB-CT-FL51-50m</i>	1	4	990 328 063	797,00	D
	2 m <i>TUB-CT-FL51-2m</i>	1	-	990 328 080	37,10	D
	flat 51 sleeve for installation-friendly ComfoTube connection, including locking slide and O-ring <i>CON-CT-FL51-M</i>	1	57	990 322 014	17,70	C
	Bend flat 51 H for horizontal 90° bend, connects to ComfoTube flat 51, including 2 O-rings and 2 locking slides <i>BEN-FL51x90-HOR</i>	1	15	990 322 012	26,40	C
	Bend flat 51 V for vertical 90° bend, connects to ComfoTube flat 51, including 2 O-rings and 2 locking slides <i>BEN-FL51x90-VER</i>	1	36	990 322 011	24,20	C
	Junction 90 / 75 to flat 51 for connecting to ComfoTube flat 51 and ComfoTube 90 / 75, including 3 O-rings and 3 locking slides <i>TRA-DN90/75/FL51</i>	1	10	990 322 013	17,10	C
	Junction 90 to flat 51, 90° bend for vertical 90° bend, connection to ComfoTube flat 51 and ComfoTube 90, including 2 O-rings and 2 locking slides <i>TRA-FL51/DN90x90</i>	1	20	990 322 046	21,60	C
	Junction 2 x 75 to flat 51 for connecting to ComfoTube flat 51 and ComfoTube 75, including 3 O-rings and 3 locking slides, with Zehnder RapidLock® <i>TRA-CT-FL51/2DN75-RLC</i>	1	20	990 322 150	20,90	C
	Y piece flat 51 for branch, connection to ComfoTube flat 51, including 3 O-rings and 3 locking slides, air volume max. 45 m³/h at normal ventilation level <i>YPI-FL51/FL51/FL51</i>	1	14	990 322 151	40,30	C
	Cross-piece flat 51 for crossing flat 51, including 4 O-rings and 4 locking slides <i>TRA-ADJ-4xFL51</i>	1	9	990 322 154	59,10	C
	End cap flat 51 for ComfoTube 51 to protect against dirt during installation 10 pieces <i>CAP-CT-FL51-10PC</i>	1	10	990 328 252	68,10	C
	Mounting bracket flat 51 10 pieces <i>MAC-FL51-MB-10PC</i>	1	50	990 322 016	46,10	C



OnFloor air distribution						
Product	Description	PU 1	PU 2	Article no.	Gross price €	Discount group
	ComfoSet flat 51 air flow regulator <i>RES-CT-CS-FL51</i>	1	25	990 322 015	24,50	C
	Grille housing CLF for wall, floor or ceiling installation, connection for ComfoTube flat 51, including O-ring and locking slide <i>OUT-CLF-FL51</i> For designer grilles, see overview on page 75/76.	1	10	990 322 000	55,20	C
	CLRf round grille housing, lateral connects to ComfoTube flat 51 with 90° bend, for wall and ceiling mounting, including O-ring and locking slide <i>OUT-CLRf-FL51-Z-DN125</i> For designer grilles, see overview on page 76.	1	10	990 322 060	54,80	C
	CLRf round grille housing, lateral 2x connection to ComfoTube flat 51 <i>OUT-CLRf-2FL51-Z_DN125</i> For designer grilles, see overview on page 76.	1	10	990 322 063	70,70	C
	Round grille housing CLRf, frontal straight connection to ComfoTube flat 51 bend, for wall and ceiling installation, including O-ring and locking slide <i>OUT-CLRf-FL51-C-DN125</i> For designer grilles, see overview on page 76.	1	12	990 322 061	54,80	C
	Cutting templates to protect the finished wall or floor space when cutting the vents. Set of cutting templates, CLF and CLRf, 3 pieces <i>MAC-CLF/CLRf-CUT-SET</i>	1	-	990 322 094	87,70	B
Renovation valves						
	Grille housing for refurbishment valve for connecting refurbishment valve to ComfoTube flat 51 Length = 400 mm, eccentric <i>OUT-REN-FL51-L400</i>	1	32	990 322 062	38,40	C
	Grille housing for refurbishment valve for connecting refurbishment valve to ComfoTube 1 x DN 90 Length = 400 mm, centric <i>OUT-REN-DN90-L400</i>	1	32	990 320 062	38,40	C
	High-induction refurbishment supply air valve, round DN 90, Ø = 105 mm, suitable for grille housing 990 320 062 and 990 322 062 Plastic, white <i>DGR-REN-DN90-D105-9016</i>	1	280	990 326 254	20,00	C
	Refurbishment extract air valve, square DN 90, 180 x 112 mm, suitable for grille housing 990 320 062 and 990 322 062 Plastic, white <i>DGR-REN-DN90-L180-W112-9016</i>	1	232	990 326 253	38,40	C

Overview of InFloor and OnFloor designer grilles

Grill housing		CLD-P		CLD wide		CLF	
		Designer grilles from page 77		Designer grilles from page 78		Designer grilles from page 80	
Designer grilles		Stainless steel	White	Stainless steel	White	Stainless steel	White
Roma		990 320 610	990 320 611*	990 320 617	990 320 618*	990 322 081	990 322 080*
Pisa		990 320 620	990 320 621*	990 320 624	990 320 627*	990 322 083	990 322 082*
Torino		990 320 630	990 320 631*	990 320 634	990 320 636*	990 322 085	990 322 084*
Venezia		990 320 640	990 320 641*	990 320 648	990 320 647*	990 322 087	990 322 086*
Genoa		990 320 660*	990 320 661*	990 320 662*	990 320 663*		

* Not suitable for floor installation

Overview of round and square InFloor and OnFloor designer grilles

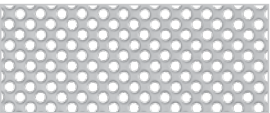
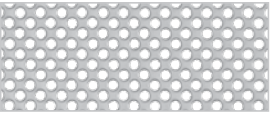
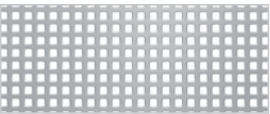
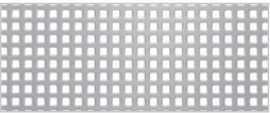





Grill housing	TVA-P		CLRF	
	Designer grilles from page 81		Designer grilles from page 81	
Designer grilles	Stainless steel	White	Stainless steel	White
Sans soucis round 	990 322 116	990 322 117	990 322 116	990 322 117
Sacré coeur round 	990 322 118	990 322 119	990 322 118	990 322 119
Venezia round 	990 320 780	990 320 781	990 320 780	990 320 781
Venezia square 	990 322 089	990 322 090	990 322 089	990 322 090
Torino round 	990 320 790	990 320 791	990 320 790	990 320 791
Torino square 	990 322 088	990 320 792	990 322 088	990 320 792

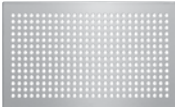

Supply air valve		
ComfoValve Luna S125 	705 613 126*	705 613 126*

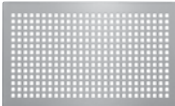
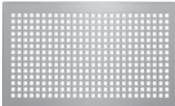

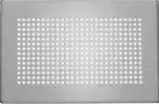

* Bulk pack of 24, see page 82

Extract air valve		
ComfoValve Luna E125 with filter 	705 613 127	705 613 127
ComfoValve Luna E125 without filter	705 613 128*	705 613 128*





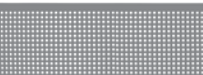

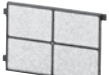

* Bulk pack of 24, see page 82

InFloor designer grilles						
Product	Description	PU 1	PU 2	Article no.	Gross price €	Discount group
 <p>Zehnder Roma</p>	Supply and extract air designer grille dimensions: 260 x 160 mm, suitable for CLD-P, CLD-WC for installation in walls, ceilings and floors					
	ComfoGrid Roma decorative grille, stainless steel <i>DGR-CLD-L260-W160-Roma-INOX</i>	1	20	990 320 610	50,40	C
	ComfoGrid Roma decorative grille, RAL 9016 (not suitable for use as a floor grille) <i>DGR-CLD-L260-W160-Roma-9016</i>	1	20	990 320 611	50,40	C
 <p>Zehnder Pisa</p>	Supply and extract air designer grille dimensions: 260 x 160 mm, suitable for CLD-P, CLD-WC for installation in walls, ceilings and floors					
	ComfoGrid Pisa decorative grille, stainless steel <i>DGR-CLD-L260-W160-Pisa-INOX</i>	1	20	990 320 620	50,40	C
 <p>Zehnder Torino</p>	ComfoGrid Pisa decorative grille, RAL 9016 (not suitable for use as a floor grille) <i>DGR-CLD-L260-W160-Pisa-9016</i>	1	20	990 320 621	50,40	C
	Supply and extract air designer grille dimensions: 260 x 160 mm, suitable for CLD-P, CLD-WC for installation in walls, ceilings and floors					
 <p>Zehnder Torino</p>	ComfoGrid Torino decorative grille, stainless steel <i>DGR-CLD-L260-W160-Torino-INOX</i>	1	20	990 320 630	50,40	C
	ComfoGrid Torino decorative grille, RAL 9016 (not suitable for use as a floor grille) <i>DGR-CLD-L260-W160-Torino-9016</i>	1	20	990 320 631	50,40	C
 <p>Zehnder Venezia</p>	Supply and extract air designer grille dimensions: 260 x 160 mm, suitable for CLD-P, CLD-WC for installation in walls, ceilings and floors					
	ComfoGrid Venezia decorative grille, stainless steel <i>DGR-CLD-L260-W160-Venezia-INOX</i>	1	20	990 320 640	50,40	C
 <p>Zehnder Venezia</p>	ComfoGrid Venezia decorative grille, RAL 9016 (not suitable for use as a floor grille) <i>DGR-CLD-L260-W160-Venezia-9016</i>	1	20	990 320 641	50,40	C
	Supply and extract air designer grille dimensions: 260 x 160 mm, suitable for CLD-P, CLD-WC for installation in walls and ceilings, not for floors					
 <p>Zehnder Genua</p>	ComfoGrid Genua decorative grille, stainless steel (not suitable for use as a floor grille) <i>DGR-CLD-L260-W160-Genua-INOX</i>	1	20	990 320 660	50,40	C
	ComfoGrid Genua decorative grille, RAL 9016 (not suitable for use as a floor grille) <i>DGR-CLD-L260-W160-Genua-9016</i>	1	20	990 320 661	50,40	C
	Telescopic frame for floor installation, CLD-P, CLD-WC					
	60 – 95 mm <i>FRA-DGR-FLO-L260-W160-H60/95</i>	1	40	990 320 370	96,90	C
	90 – 160 mm <i>FRA-DGR-FLO-L260-W160-H90/160</i>	1	40	990 320 371	107,40	C
	155 – 230 mm <i>FRA-DGR-FLO-L260-W160-H155/230</i>	1	40	990 320 373	120,70	C







InFloor designer grilles						
Product	Description	PU 1	PU 2	Article no.	Gross price €	Discount group
 Zehnder Roma	Designer grille for supply air with 20 mm edge covering dimensions: 300 x 200 mm, suitable for CLD-P and CLD-WC, for installation in floors ComfoGrid Roma decorative grille, stainless steel <i>DGR-CLD-L300-W200-Roma-INOX</i>	1	20	990 320 612	56,20	C
 Zehnder Torino	Designer grille for supply air with 20 mm edge covering dimensions: 300 x 200 mm, suitable for CLD-P and CLD-WC, for installation in floors ComfoGrid Torino decorative grille, stainless steel <i>DGR-CLD-L300-W200-Torino-INOX</i>	1	20	990 320 632	56,20	C
 Zehnder Venezia	Designer grille for supply air with 20 mm edge covering dimensions: 300 x 200 mm, suitable for CLD-P and CLD-WC, for installation in floors ComfoGrid Venezia decorative grille, stainless steel <i>DGR-CLD-L300-W200-Venezia-INOX</i>	1	20	990 320 642	56,20	C

InFloor designer grilles						
Product	Description	PU 1	PU 2	Article no.	Gross price €	Discount group
 Zehnder Pisa	Supply and extract air designer grille dimensions: 430 x 160 mm, suitable for CLD wide, for installation in walls, ceilings and floors					
	ComfoGrid Pisa decorative grille, stainless steel <i>DGR-CLD-L430-W160-Pisa-INOX</i> ComfoGrid Pisa decorative grille, RAL 9016 (not suitable for use as a floor grille) <i>DGR-CLD-L430-W160-Pisa-9016</i>	1	10	990 320 624	64,20	C
 Zehnder Venezia	Supply and extract air designer grille dimensions: 430 x 160 mm, suitable for CLD wide, for installation in walls, ceilings and floors					
	ComfoGrid Venezia decorative grille, stainless steel <i>DGR-CLD-L430-W160-Venezia-INOX</i> ComfoGrid Venezia decorative grille, RAL 9016 (not suitable for use as a floor grille) <i>DGR-CLD-L430-W160-Venezia-9016</i>	1	10	990 320 648	64,20	C
 Zehnder Roma	Supply and extract air designer grille dimensions: 430 x 160 mm, suitable for CLD wide, for installation in walls, ceilings and floors					
	ComfoGrid Roma decorative grille, stainless steel <i>DGR-CLD-L430-W160-Roma-INOX</i> ComfoGrid Roma decorative grille, RAL 9016 (not suitable for use as a floor grille) <i>DGR-CLD-L430-W160-Roma-9016</i>	1	10	990 320 617	64,20	C
 Zehnder Torino	Supply and extract air designer grille dimensions: 430 x 160 mm, suitable for CLD wide, for installation in walls, ceilings and floors					
	ComfoGrid Torino decorative grille, stainless steel <i>DGR-CLD-L430-W160-Torino-INOX</i> ComfoGrid Torino decorative grille, RAL 9016 (not suitable for use as a floor grille) <i>DGR-CLD-L430-W160-Torino-9016</i>	1	10	990 320 634	64,20	C
 Zehnder Genua	Supply and extract air designer grille dimensions: 430 x 160 mm, suitable for CLD wide, for installation in walls and ceilings, not for floors					
	ComfoGrid Genua decorative grille, stainless steel (not suitable for use as a floor grille) <i>DGR-CLD-L430-W160-Genua-INOX</i> ComfoGrid Genua decorative grille, RAL 9016 (not suitable for use as a floor grille) <i>DGR-CLD-L430-W160-Genua-9016</i>	1	10	990 320 662	64,20	C
	Telescopic frame for floor installation CLD wide 60 – 95 mm <i>FRA-DGR-FLO-L430-W160-H60/95</i>	1	-	988 320 370	221,50	C
	155 – 230 mm <i>FRA-DGR-FLO-L430-W160-H155/230</i>	1	-	988 320 369	240,20	C
	Replacement filter for extract air housing CLD-P and CLD-WC ISO Coarse ≥ 45 % 10 pieces Two filters are required for CLD wide <i>FIL-CLD-L158-W113-H9-CRS-45%-10PC-WHITE</i>	1	540	990 320 575	87,30	B

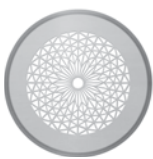











OnFloor designer grilles



Product	Description	PU 1	PU 2	Article no.	Gross price €	Discount group
 Zehnder Roma	Supply and extract air designer grille dimensions: 350 x 130 mm, suitable for CLF, for installation in walls, ceilings and floors					
	 ComfoGrid Roma decorative grille, stainless steel <i>DGR-CLF-L350-W130-Roma-INOX</i>	1	10	990 322 081	67,40	C
	ComfoGrid Roma decorative grille, RAL 9016 (not suitable for use as a floor grille) <i>DGR-CLF-L350-W130-Roma-9016</i>	1	10	990 322 080	67,40	C
 Zehnder Pisa	Supply and extract air designer grille dimensions: 350 x 130 mm, suitable for CLF, for installation in walls, ceilings and floors					
	 ComfoGrid Pisa decorative grille, stainless steel <i>DGR-CLF-L350-W130-Pisa-INOX</i>	1	10	990 322 083	67,40	C
	ComfoGrid Pisa decorative grille, RAL 9016 (not suitable for use as a floor grille) <i>DGR-CLF-L350-W130-Pisa-9016</i>	1	10	990 322 082	67,40	C
 Zehnder Torino	Supply and extract air designer grille dimensions: 350 x 130 mm, suitable for CLF, for installation in walls, ceilings and floors					
	ComfoGrid Torino decorative grille, stainless steel <i>DGR-CLF-L350-W130-Torino-INOX</i>	1	10	990 322 085	67,40	C
	ComfoGrid Torino decorative grille, RAL 9016 (not suitable for use as a floor grille) <i>DGR-CLF-L350-W130-Torino-9016</i>	1	10	990 322 084	67,40	C
 Zehnder Venezia	Supply and extract air designer grille dimensions: 350 x 130 mm, suitable for CLF, for installation in walls, ceilings and floors					
	ComfoGrid Venezia decorative grille, stainless steel <i>DGR-CLF-L350-W130-Venezia-INOX</i>	1	10	990 322 087	67,40	C
	ComfoGrid Venezia decorative grille, RAL 9016 (not suitable for use as a floor grille) <i>DGR-CLF-L350-W130-Venezia-9016</i>	1	10	990 322 086	67,40	C
	ComfoGrid CLF decorative grille, RAL 9016 plastic dimensions: 330 x 110 mm, suitable for CLF, for installation in walls, ceilings and floors, white plastic <i>DGR-CLF-L350-W110-Plastic-9016</i>	1	25	990 322 001	23,00	C
	Cross-bracing floor insert for designer grille CLF <i>MAC-DGR/CLF-FLO</i>	1	20	990 322 095	15,80	C
	Filter set CLF, ISO Coarse ≥ 30 % 10 pieces <i>FIL-CLF-L295-W75-CRS-30%-10PC</i>	1	70	990 322 100	76,20	B

Round InFloor and OnFloor designer grilles

Product	Description	PU 1	PU 2	Article no.	Gross price €	Discount group
 Zehnder Sans soucis	Round designer grille, extract air with filter, connector DN 125, suitable for CLRf / TVA, Ø 160 mm, for installation in walls and ceilings, not for floors ComfoGrid Sans soucis, stainless steel (not suitable for use as a floor grille) <i>DGR-DIV-DN125/160-FIL-Sans_soucis-INOX</i> ComfoGrid Sans soucis, RAL 9016 (not suitable for use as a floor grille) <i>DGR-DIV-DN125/160-FIL-Sans_soucis-9016</i>	1	10	990 322 116	128,20	C
	ComfoGrid Sans soucis, RAL 9016 (not suitable for use as a floor grille) <i>DGR-DIV-DN125/160-FIL-Sans_soucis-9016</i>	1	10	990 322 117	128,20	C
 Zehnder Sacré coeur	Round designer grille, extract air with filter, connector DN 125, suitable for CLRf / TVA, Ø 160 mm, for installation in walls and ceilings, not for floors ComfoGrid Sacré coeur, stainless steel (not suitable for use as a floor grille) <i>DGR-DIV-DN125/160-FIL-Sacre_coeur-INOX</i> ComfoGrid Sacré coeur, RAL 9016 (not suitable for use as a floor grille) <i>DGR-DIV-DN125/160-FIL-Sacre_coeur-9016</i>	1	10	990 322 118	128,20	C
	ComfoGrid Sacré coeur, RAL 9016 (not suitable for use as a floor grille) <i>DGR-DIV-DN125/160-FIL-Sacre_coeur-9016</i>	1	10	990 322 119	128,20	C
 Zehnder Venezia	Round designer grille, extract air with filter, connector DN 125, suitable for CLRf / TVA, Ø 160 mm, for installation in walls and ceilings, not for floors ComfoGrid Venezia, stainless steel (not suitable for use as a floor grille) <i>DGR-DIV-DN125/160-FIL-Venezia-INOX</i> ComfoGrid Venezia, RAL 9016 (not suitable for use as a floor grille) <i>DGR-DIV-DN125/160-FIL-Venezia-9016</i>	1	10	990 320 780	49,80	C
	ComfoGrid Venezia, RAL 9016 (not suitable for use as a floor grille) <i>DGR-DIV-DN125/160-FIL-Venezia-9016</i>	1	10	990 320 781	49,80	C
 Zehnder Torino	Round designer grille, extract air with filter, connector DN 125, suitable for CLRf / TVA, Ø 160 mm, for installation in walls and ceilings, not for floors ComfoGrid Torino, stainless steel (not suitable for use as a floor grille) <i>DGR-DIV-DN125/160-FIL-Torino-INOX</i> ComfoGrid Torino, RAL 9016 (not suitable for use as a floor grille) <i>DGR-DIV-DN125/160-FIL-Torino-9016</i>	1	10	990 320 790	49,80	C
	ComfoGrid Torino, RAL 9016 (not suitable for use as a floor grille) <i>DGR-DIV-DN125/160-FIL-Torino-9016</i>	1	10	990 320 791	49,80	C
 Zehnder Venezia	Square designer grille, extract air with filter, connector DN 125, suitable for CLRf / TVA, 160 x 160 mm, for installation in walls and ceilings, not for floors ComfoGrid Venezia, stainless steel (not suitable for use as a floor grille) <i>DGR-DIV-DN125/L160-W160-FIL-Venezia-INOX</i> ComfoGrid Venezia, RAL 9016 (not suitable for use as a floor grille) <i>DGR-DIV-DN125-Q160-FIL-Venezia-9016</i>	1	10	990 322 089	49,80	C
	ComfoGrid Venezia, RAL 9016 (not suitable for use as a floor grille) <i>DGR-DIV-DN125-Q160-FIL-Venezia-9016</i>	1	10	990 322 090	49,80	C
 Zehnder Torino	Square designer grille, extract air with filter, connector DN 125, suitable for CLRf / TVA, 160 x 160 mm, for installation in walls and ceilings, not for floors ComfoGrid Torino, stainless steel (not suitable for use as a floor grille) <i>DGR-DIV-DN125-Q160-FIL-Torino-INOX</i> ComfoGrid Torino, RAL 9016 (not suitable for use as a floor grille) <i>DGR-DIV-DN125-Q160-FIL-Torino-9016</i>	1	10	990 322 088	49,80	C
	ComfoGrid Torino, RAL 9016 (not suitable for use as a floor grille) <i>DGR-DIV-DN125-Q160-FIL-Torino-9016</i>	1	10	990 320 792	49,80	C
	Filter set DN 125, ISO Coarse ≥ 45 % suitable for extract air valves and designer grilles CLRf / TVA 10 pieces <i>FIL-DIV-DN125-CRS-45%-10PC</i>	1	20	990 320 032	32,30	B

InFloor and OnFloor valves

Product	Description	PU 1	PU 2	Article no.	Gross price €	Discount group
    	Supply air valve ComfoValve Luna S125 DN 125, Ø 170, suitable for CLRf/TVA-P Plastic, white <i>VAL-SUP-LUN1-DN125-PLS-9003</i>	1	-	705 613 126	39,80	C
	Supply air valve ComfoValve Luna S125 - bulk pack of 24 DN 125, Ø 170, suitable for CLRf / TVA-P, plastic, white (bulk pack of 24) <i>VAL-SUP-LUN1-DN125-PLS-9003-24PC</i>	1	-	705 613 125	786,00	C
	Supply air valve ComfoValve Luna S125 DN 125, Ø 170, suitable for CLRf/TVA-P Plastic, black <i>VAL-SUP-LUN1-DN125-PLS-black</i>	1	-	705 613 135	43,80	C
	AirBlocker outflow restrictor suitable for ComfoValve Luna S125, for restricting the outflow angle to 240° <i>RES-LUN1-DN125</i>	1	-	705 613 001	13,90	C
    	Extract air valve ComfoValve Luna E125 DN 125, Ø 170, suitable for CLRf/TVA-P Plastic, white <i>VAL-ETA-LUN-DN125-PLS-9003</i>	1	-	705 613 128	39,60	C
	Extract air valve ComfoValve Luna E125 - with filter DN 125, Ø 170, suitable for CLRf / TVA-P Plastic, white, with filter <i>VAL-ETA-LUN-DN125-PLS-9003-FIL</i>	1	-	705 613 127	42,10	C
	Extract air valve ComfoValve Luna E125 - bulk pack of 24 DN 125, Ø 170, suitable for CLRf/ TVA-P, plastic, white, without filter (bulk pack of 24) <i>VAL-ETA-LUN-DN125-PLS-9003-24PC</i>	1	-	705 613 129	783,30	C
	Extract air valve ComfoValve Luna E125 DN 125, Ø 170, suitable for CLRf / TVA-P Plastic, black <i>VAL-ETA-LUN-DN125-PLS-black</i>	1	-	705 613 133	43,80	C
	Extract air valve ComfoValve Luna E125 - with filter DN 125, Ø 170, suitable for CLRf / TVA-P Plastic, black, with filter <i>VAL-ETA-LUN-DN125-PLS-black-FIL</i>	1	-	705 613 134	46,30	C
	Filter set DN 100, ISO Coarse ≥ 45 % (G3) suitable for Luna E125, extract valves and designer grills 10 pieces <i>FIL-DIV-DN100-CRS-45%-10PC</i>	1	20	990 320 031	29,30	B
 Extract valve STC 100/125 DN 100/125, Ø 150, suitable for CLRf / TVA, plastic, white <i>VAL-ETA-STC-DN100/125</i>	1	40	705 051 021	15,60	C	
 Filter set DN 125, ISO Coarse ≥ 45 % (G3) suitable for extract air valves and designer grilles CLRf / TVA 10 pieces <i>FIL-DIV-DN125-CRS-45%-10PC</i>	1	20	990 320 032	32,30	B	

Service				
Product	Description	Article no.	Gross price €	Discount group
	Air distribution cleaning set suitable for ComfoTube 75 / 90 and flat 51. Including adapter for grille housing CLD(-P), CLF, CLRf and TVA(-P) as well as vacuum cleaner connectors, reel length 15 metres <i>UTL-BRU-SET</i>	990 000 106	1.952,10	B
	ComfoTool Pipe cutter ComfoTube DN75 / DN90 <i>UTL-CT-DN75/90</i>	990 000 110	30,30	C
	CO₂ data logger for measuring and recording carbon dioxide, air temperature and humidity in closed interiors. Including time and date display, plug, USB data cable, PC software. <i>MEQ-CO2</i>	990 000 100	198,60	net



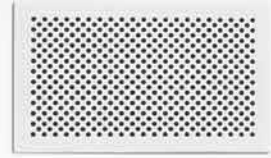







Zehnder outdoor and exhaust air

86 – 93



Overview of components for outdoor air and exhaust air connectors	86
Overview of connection components for brine-earth heat exchangers	87
ComfoFond-L Q brine-earth heat exchangers	88
ComfoVent facade system	90
Outdoor air and exhaust air connectors	93







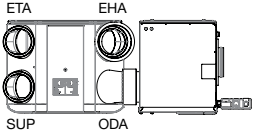
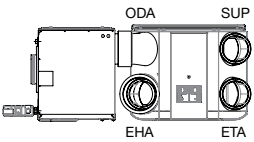

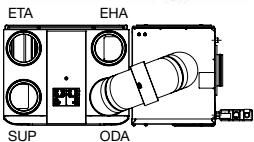
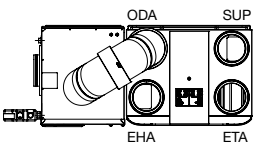
Overview of components for outdoor air and exhaust air connectors

Outdoor air/ exhaust air connector	External wall grille 125	Roof housing 125	External wall grille 160	Roof housing 160	Roof housing 160	External wall grille 180	ComfoVent 180	External wall grille 200	Roof housing 200
Connection line									
Aluminium lined flexible duct 125 	Direct	Direct							
Aluminium lined flexible duct 160 			Direct	Direct	Connection nipple DN 160 990 326 331				
Aluminium lined flexible duct 200 								Direct	Direct
ComfoPipe Compact 125 	Direct	Direct							
ComfoPipe Compact 160 			Direct	Direct	Connection nipple DN 160 990 326 331				
ComfoPipe Compact 200 								Direct	Direct
ComfoPipe Plus 160 			Direct	Direct	Connection nipple DN 160 990 326 331				
ComfoPipe Plus 200 						Junction 990 430 739	Junction 990 430 739	Direct	Direct

Overview of connection components for brine-earth heat exchangers		
	ComfoAir Q350/450 TR ComfoFond-L Q TR 	ComfoAir Q600 ST ComfoFond-L Q ST 
ComfoPipe Compact 160 	ComfoPipe Compact 160/180 junction 990 328 664	
ComfoPipe Compact 200 		ComfoPipe Compact 180 x 200 junction 990 326 341
ComfoPipe Plus 160 	ComfoPipe Plus Connector set 990 328 750	
ComfoPipe Plus 200 		ComfoPipe Plus Connector set 990 328 751

Brine-earth heat exchangers

Product	Description	PU 1	PU 2	Article no.	Gross price €	Discount group
ComfoFond-L Q						
	<p>ComfoFond-L Q TR brine-earth heat exchanger including upstream filter G4 and complete hydraulics for up to 450 m³/h supply air volume flow rate</p> <p>Accessories required: ComfoAir Q350/450/600 option box, dry siphon 5/4"</p> <p>Support frame not included</p>					
	<p>ComfoFond-L Q L TR brine-earth heat exchanger for ComfoAir Q350/450 TR on left <i>CF-LIQ-CAQ-L-SLN</i></p>	1	-	471 310 082	2.429,60	B
	<p>ComfoFond-L Q R TR brine-earth heat exchanger for ComfoAir Q350/450 TR on right <i>CF-LIQ-CAQ-R-SLN</i></p>	1	-	471 310 083	2.429,60	B
ComfoFond-L Q ST brine-earth heat exchanger						
	<p>ComfoFond-L Q ST brine-earth heat exchanger including prefilter G4, complete hydraulics and connecting bend for up to 600 m³/h supply air volume flow rate</p> <p>Accessories required: ComfoAir Q350/450/600 option box, dry siphon 5/4"</p> <p>Support frame not included</p>					
	<p>ComfoFond-L Q L ST brine-earth heat exchanger for ComfoAir Q600 ST on left <i>CF-LIQ-CAQ-L-STT</i></p>	1	-	471 310 084	2.735,10	B
	<p>ComfoFond-L Q R ST brine-earth heat exchanger for ComfoAir Q600 ST on right <i>CF-LIQ-CAQ-R-STT</i></p>	1	-	471 310 085	2.735,10	B

Brine-earth heat exchangers						
Product	Description	PU 1	PU 2	Article no.	Gross price €	Discount group
ComfoFond-L Q accessories						
 	Option Box ComfoAir Q350/450/600 for additional connection options for CO ₂ and humidity sensors as well as ComfoFond-L Q. ComfoFond-L Q only: When combined with ComfoFond-L Q, connection cable 400 300 311 needs to be ordered separately. <i>OPB-CAQ-LIGHT VERSION-V2</i>	1	-	471 502 143	179,20	C
 	Connection cable for use of OptionBox combined with ComfoFond-L Q, lenght 2,5 m <i>PSP-CAB-OPB-230V-10A-PCK</i>	1	-	400 300 311	35,50	C
	ComfoFond-L Q TR floor stand height = 355 mm <i>FRA-CF-LIQ-CAQ-SLN</i>	1	-	471 310 086	218,90	B
	ComfoFond-L Q ST floor stand height = 315 mm <i>FRA-CF-LIQ-CAQ-ST</i>	1	-	471 310 087	218,90	B
	Dry siphon 5/4" for ComfoFond-L Q <i>SIP-5/4"-CA350/550-CF-L</i>	1	20	990 201 330	62,40	C
	Filter for ComfoFond-L Q, ISO Coarse ≥ 60 % (G4) 1 piece <i>FIL-CRS-SPR-P</i>	1	-	400 100 066	28,00	B

Example applications for the ComfoVent facade system

1 ComfoVent 180 System 1
above ground level

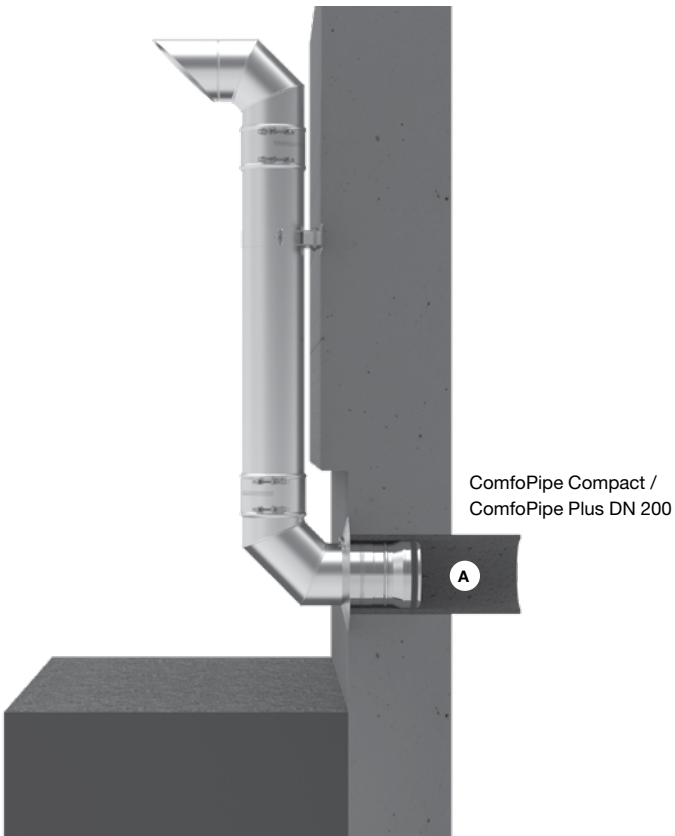



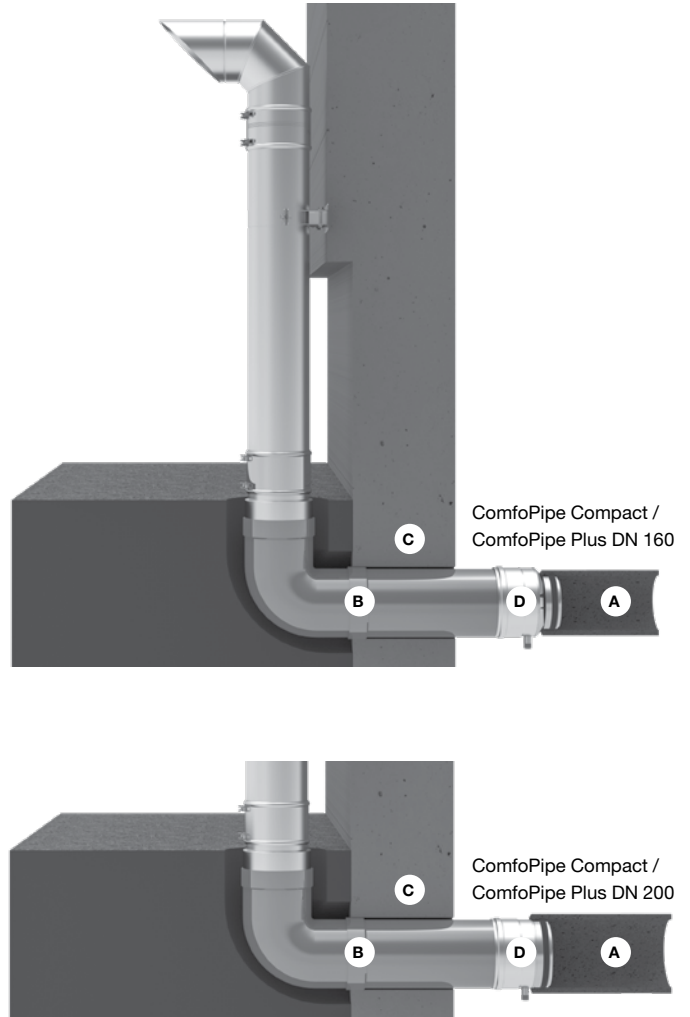











2 ComfoVent 180 System 2
under ground level













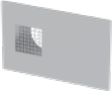



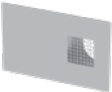



- A** ComfoPipe Compact / ComfoPipe Plus
- B** Underground line DN 200 (on site)
- C** Wall duct, resistant to pressurised water if necessary (on site)
- D** Condensation drain with adaptor for ComfoPipe Compact / ComfoPipe Plus

Facade system						
Product	Description	PU 1	PU 2	Article no.	Gross price €	Discount group
ComfoVent						
<p>1</p>	<p>Facade system 1 for air flow of the outdoor air or exhaust air above ground level and for connection to ComfoPipe Compact / Plus, material stainless steel Set consists of: 1 x outdoor air bend (with seal and clamp fitting) 1 x length element L = 1080 mm (with seal and clamp fitting) 1 x 90° bend with seal 1 x wall bracket (adjustable 50-90 mm) 1 x adaptor DN 180 to ComfoPipe Compact /Plus DN 200 1 x wall rosette</p> <p>ComfoVent 180 system 1 to ComfoPipe Compact / ComfoPipe Plus DN 200, above ground level <i>EAC-CV-DN180/200-GPCP-SET1</i></p> <p>Note: Going through the wall, ComfoPipe Compact DN 200 (990 328 696) or ComfoPipe Plus DN 200 (990 328 720) must be used (not included). Is a connection DN 160 coming from the ventilation unit intended, a reduction adaptor (990 326 349) can be used as transition from ComfoPipe Compact / Plus DN 200 on to ComfoPipe Compact / Plus DN 160.</p>	1	2	990 430 740	947,20	C
<p>2</p>	<p>Facade system 2 for air flow of the outdoor air or exhaust air via on-site plastic tube laid in the ground and for connection to ComfoPipe, material stainless steel Set consists of: 1 x outdoor air bend (with seal and clamp fitting) 1 x length element L = 1080 mm (with seal and clamp fitting) 1 x junction to plastic tube DN 200 1 x condensate drain with adaptor to ComfoPipe Compact / ComfoPipe Plus with seal 1 x wall bracket (adjustable 50-90 mm)</p> <p>ComfoVent 180 system 2 to ComfoPipe Compact / ComfoPipe Plus DN 160, below ground level <i>EAC-CV-DN180/160-GPCP-SET2</i></p> <p>ComfoVent 180 system 2 to ComfoPipe Compact / ComfoPipe Plus DN 200, below ground level <i>EAC-CV-DN180/200-GPCP-SET2</i></p> <p>Note: Earth-laid, hygienically safe, as air duct suitable plastic pipe DN 200 is not included in the scope of delivery and must be provided on site.</p>	1	2	990 430 741	947,20	C
		1	2	990 430 742	947,20	C

Facade system						
Product	Description	PU 1	PU 2	Article no.	Gross price €	Discount group
ComfoVent						
	ComfoVent length element 360 mm, stainless steel with seal, clamp fitting D = 180 mm <i>TUB-CV-DN180-L360-INOX</i>	1	12	990 430 706	122,60	C
	ComfoVent length element 540 mm, stainless steel with seal, clamp fitting D = 180 mm <i>TUB-CV-DN180-L540-INOX</i>	1	12	990 430 705	140,10	C
	ComfoVent length element 1080 mm, stainless steel with seal, clamp fitting D = 180 mm <i>TUB-CV-DN180-L1080-INOX</i>	1	18	990 430 704	185,60	C
	ComfoVent 90° bend D = 180 mm, stainless steel with seal, clamp fitting D = 180 mm <i>BEN-CV-DN180X90-INOX</i>	1	12	990 430 711	220,20	C
	Inlet/outlet unit made from stainless steel with clamp fitting and seal, suitable for outdoor air and exhaust air ComfoVent outdoor air bend D = 180 mm <i>EAC-CV-DN180X90-INOX</i>	1	12	990 430 718	395,00	C
	Wall rosette, stainless steel, suitable for covering wall cut-out Wall rosette 180 mm <i>MAC-CV-DN180-WMO</i>	1	-	990 430 731	48,00	C
	Clamp fitting for locking and sealing the connection Clamp fitting 180 mm , with adjustable quick fastener <i>CON-CV-DN180</i>	1	-	990 430 730	43,90	C
	ComfoVent converter 180 mm, stainless steel made of stainless steel, with sealing, as connection between ComfoVent (System 1) D = 180 mm and on-site ComfoPipe Compact / Plus tube DN 200 <i>TRA-CV-DN180/200-M/N</i>	1	32	990 430 739	164,10	C
	Wall bracket, stainless steel for fastening the standpipes to the facade Wall bracket 180 mm , wall clearance 50 – 90 mm <i>MAC-CV-DN180</i>	1	-	990 430 732	140,10	C

Facade system						
Product	Description	PU 1	PU 2	Article no.	Gross price €	Discount group
Outdoor air / exhaust air connector						
	Roof housing for pitched roof DN 125 for roof pitches of 6° – 60° including universal roof tile, installation template, fastening material and sealing flange Colour: red, RAL 8004, available until 31.12.2024 <i>EAC-ROH-DN125-6°/60°-8004</i> Colour: black, RAL 9005 <i>EAC-ROH-DN125-6°/60°-9005</i>	1	-	990 430 610	308,50	C
		1	-	990 430 611	308,50	C
	Roof housing for pitched roof DN 160 for roof pitches of 6° – 60° including universal roof tile, installation template, fastening material and sealing flange Colour: red, RAL 8004 <i>EAC-ROH-DN160-6°/60°-8004</i> Colour: black, RAL 9005 <i>EAC-ROH-DN160-6°/60°-9005</i>	1	-	990 430 612	613,80	C
		1	-	990 430 613	613,80	C
	Roof housing for pitched roof DN 200 for roof pitches of 6° – 60° including universal roof tile, installation template, fastening material and sealing flange Colour: red, RAL 8004 <i>EAC-ROH-DN200-6°/60°-8004</i> Colour: black, RAL 9005 <i>EAC-ROH-DN200-6°/60°-9005</i>	1	-	990 430 614	667,10	C
		1	-	990 430 615	667,10	C
	Roof housing for flat roof DN 160 black, with flat roof collar <i>EAC-ROH-DN160-9005</i>	1	-	990 430 604	378,00	C
	External wall grille for wall installation DN 125 up to 200 m³/h <i>EAC-DN125-125M3H-L248-W267-H37-INOX</i>	1	20	990 430 250	101,00	C
	DN 160 up to 450 m³/h <i>EAC-DN160-350M3H-L280-W280-H37-INOX</i>	1	20	990 430 584	106,10	C
	DN 200 up to 600 m³/h <i>EAC-DN200-500M3H-L330-W330-H37-INOX</i>	1	20	990 430 585	146,90	C

Facade system

Product	Description	PU 1	PU 2	Article no.	Gross price €	Discount group
Outdoor air / exhaust air connector						
 	Combined external ComfoEdge Dupla DN125 for compact connection of the outdoor and exhaust air in one element					
 	ComfoEdge Dupla combined external wall grille right, galvanised sheet steel connector DN 125, nominal air volume 120 m ³ /h <i>EAC-DN125-EHA-ODA-R-Dupla-INOX</i>	1	-	990 430 573	255,00	C
 	ComfoEdge Dupla combined external wall grille right, galv. sheet steel, RAL 9016 connector DN 125, nominal air volume 120 m ³ /h <i>EAC-DN125-EHA-ODA-R-Dupla-9016</i>	1	-	990 430 571	267,00	C
 	ComfoEdge Dupla combined external wall grille left, galvanised sheet steel connector DN 125, nominal air volume 120 m ³ /h <i>EAC-DN125-EHA-ODA-L-Dupla-INOX</i>	1	-	990 430 572	255,00	C
 	ComfoEdge Dupla combined external wall grille left, galv. sheet steel, RAL 9016 connector DN 125, nominal air volume 120 m ³ /h <i>EAC-DN125-EHA-ODA-L-Dupla-9016</i>	1	-	990 430 570	267,00	C
 	Combined external ComfoEdge Dupla DN 160 for compact connection of the outdoor and exhaust air in one element					
 	ComfoEdge Dupla combined external wall grille right, galvanised sheet steel connector DN 160, nominal air volume 270 m ³ /h <i>EAC-DN160-EHA-ODA-R-Dupla-INOX</i>	1	-	990 430 577	343,00	C
 	ComfoEdge Dupla combined external wall grille right, galv. sheet steel, RAL 9016 connector DN 160, nominal air volume 270 m ³ /h <i>EAC-DN160-EHA-ODA-R-Dupla-9016</i>	1	-	990 430 575	359,00	C
 	ComfoEdge Dupla combined external wall grille left, galvanised sheet steel connector DN 160, nominal air volume 270 m ³ /h <i>EAC-DN160-EHA-ODA-L-Dupla-INOX</i>	1	-	990 430 576	343,00	C
 	ComfoEdge Dupla combined external wall grille left, galv. sheet steel, RAL 9016 connector DN 160, nominal air volume 270 m ³ /h <i>EAC-DN160-EHA-ODA-L-Dupla-9016</i>	1	-	990 430 574	359,00	C

Facade system						
Product	Description	PU 1	PU 2	Article no.	Gross price €	Discount group
Outdoor air / exhaust air connector						
 See example installations on page 46	Combined external wall grille DN 125 for compact connection of the outdoor and exhaust air in one element ComfoEdge combined external wall grille right , stainless steel connector DN 125 up to 200 m ³ /h nominal flow <i>EAC-DN125-EHA-ODA-R-INOX</i>	1	-	990 430 591	184,20	C
	ComfoEdge combined external wall grille right , stainless steel, RAL 9016 connector DN 125 up to 200 m ³ /h <i>EAC-DN125-EHA-ODA-R-9016</i>	1	-	990 430 599	200,30	C
	ComfoEdge combined external wall grille left , stainless steel connector DN 125 up to 200 m ³ /h nominal flow <i>EAC-DN125-EHA-ODA-L-INOX</i>	1	-	990 430 592	184,20	C
	ComfoEdge combined external wall grille left , stainless steel, RAL 9016 connector DN 125 up to 200 m ³ /h <i>EAC-DN125-EHA-ODA-L-9016</i>	1	-	990 430 598	200,30	C
 	Combined external wall grille DN 160 for compact connection of the outdoor and exhaust air in one element Outdoor air connector right , connector DN 160 up to 300 m ³ /h nominal flow <i>EAC-DN160-EHA-ODA-R-INOX</i>	1	-	990 430 594	247,50	C
	Outdoor air connector left , connector DN 160 up to 300 m ³ /h nominal flow <i>EAC-DN160-EHA-ODA-L-INOX</i>	1	-	990 430 595	247,50	C
 	ComfoEdge combined external wall grille DN200 up to 400m³/h nominal air flow rate for compact connection of the outdoor air and exhaust air in one element. External dimensions: 676 x 337 x 212 mm Drill hole distance, centre to centre: 328.5 mm Ø Drill hole: min. 240 mm (ComfoPipe Compact), min. 290 mm (ComfoPipe Plus)					
	ComfoEdge combined external wall grille, DN200, exhaust air connection right , stainless steel <i>EAC-DN200-EHA-ODA-R-INOX</i>	1	-	990 430 596	309,40	C
	ComfoEdge combined external wall grille, DN200, exhaust air connection left , stainless steel <i>EAC-DN200-EHA-ODA-L-INOX</i>	1	-	990 430 597	309,40	C

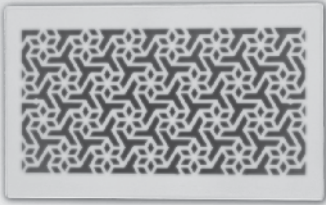























Zehnder replacement filters

98 – 104



















Replacement filters for ventilation units	98
Replacement filters for ventilation units, outdoor air intake, filter box	101
Replacement filters for heating elements, brine-earth heat exchangers, air distribution	103
Replacement filters for ComfoWell	104















Replacement filters for ventilation units

Product	Description	PU 1	PU 2	Article no.	Gross price €	Discount group
ComfoSpot 50						
	 <p>Filter set for ComfoSpot 50, ISO Coarse ≥ 70 % (G4), 2 pieces <i>FIL-CSP50-CRS/G4-2PC-PCK</i></p>	1	-	527 005 390	30,60	B
	 <p>Pollen filter set for ComfoSpot 50, ISO Coarse ≥ 70 % / ISO ePM10 ≥ 60 % (G4 / F7) 2 pieces <i>FIL-CSP50-CRS/G4-ePM10/F7-2PC-PCK</i></p>	1	-	527 005 400	33,40	B
	 <p>Filter set for ComfoSpot 50, ISO Coarse ≥ 70 % (G4), 10 pieces <i>FIL-CSP50-CRS/G4-10PC-PCK</i></p>	1	-	527 005 410	115,60	B
	 <p>Pollen filter set for ComfoSpot 50, ISO Coarse ≥ 70 % / ISO ePM10 ≥ 60 % (G4 / F7) 10 pieces <i>FIL-CSP50-CRS/G4-ePM10/F7-10PC</i></p>	1	-	527 005 420	126,80	B
ComfoAir 70						
	 <p>Filter set for ComfoAir 70, ISO Coarse ≥ 70 % (G4), 2 pieces <i>FIL-CA70-CRS/G4-2PC-PCK</i></p>	1	-	527 005 180	33,50	B
	 <p>Pollen filter set for ComfoAir 70, ISO Coarse ≥ 70 % / ISO ePM10 ≥ 60 % (G4 / F7) 2 pieces <i>FIL-CA70-CRS/G4-ePM10/F7-2PC-PCK</i></p>	1	-	527 005 190	37,10	B
	 <p>Filter set for ComfoAir 70, ISO Coarse ≥ 70 % (G4), 10 pieces <i>FIL-CA70-CRS/G4-10PC</i></p>	1	-	527 005 160	125,30	B
	 <p>Pollen filter set for ComfoAir 70, ISO Coarse ≥ 70 % / ISO ePM10 ≥ 60 % (G4 / F7) 10 pieces <i>FIL-CA70-CRS/G4-ePM10/F7-10PC</i></p>	1	-	527 005 170	134,70	B
ComfoAir 140						
	 <p>Pollen filter for ComfoAir 140, F6 1 piece <i>FIL-L220-H187-F6</i></p>	1	50	006 040 160	40,20	B









Replacement filters for ventilation units							
Product	Description	PU 1	PU 2	Article no.	Gross price €	Discount group	
ComfoAir 160							
 	Filter set for ComfoAir 160, ISO Coarse ≥ 65 % (G4), 2 pieces <i>FIL-CA160-SET-CRS/CRS</i>	1	-	400 100 023	43,40	B	
	Pollen filter set for ComfoAir 160, ISO Coarse ≥ 65 % / ISO ePM1 ≥ 65 % (G4 / F7) 2 pieces <i>FIL-CA160-SET-CRS/ePM1</i>	1	-	400 100 024	46,10	B	
Atmos 175, Thermos 200 / 300							
 	Filter for Atmos 175, Thermos 200 / 300, ISO Coarse ≥ 55 % (G4), 1 piece <i>FIL-ATM-THM-FB-EPP-DN160-CRS/G4-1PC</i>	1	-	524 000 100	25,20	B	
	Pollen filter Atmos 175, Thermos 200 / 300, ISO ePM10 ≥ 60 % (F7), 1 piece <i>FIL-ATM-THM-FB-EPP-DN160-ePM10/F7-1PC</i>	1	-	524 000 090	29,50	B	
ComfoAir 180							
 	Filter set for ComfoAir 180, ISO Coarse ≥ 65 % (G4), 2 pieces <i>FIL-CA180-SET-CRS/CRS</i>	1	-	400 100 090	43,40	B	
	Pollen filter set for ComfoAir 180, ISO Coarse ≥ 65 % / ISO ePM1 ≥ 55 % (G4 / F7) 2 pieces <i>FIL-SET-CA180-SET-CRS/EPM1</i>	1	-	400 100 091	46,10	B	
ComfoAir 200							
 	Filter set for ComfoAir 200, ISO Coarse ≥ 65 % (G4), 2 pieces <i>FIL-PFR-L292-W24-H150-CRS-2pc</i>	1	-	400 100 014	43,40	B	
	Pollen filter set for ComfoAir 200, ISO Coarse ≥ 65 % / ISO ePM1 ≥ 55 % (G4 / F7) 2 pieces <i>FIL-PFR-L292-W24-H150-SET-CRS/ePM1</i>	1	-	400 100 013	46,10	B	
Climos 200							
 	Filter set for Climos 200, ISO Coarse ≥ 75 % (M5), 2 pieces <i>FIL-CLI200-CRS/M5-2PC-PCK</i>	1	-	527 004 270	49,30	B	
	Pollen filter set for Climos 200, ISO Coarse ≥ 75 % / ISO ePM1 60 % (M5 / F7) 2 pieces <i>FIL-CLI200-CRS/M5-ePM1/F7-2PC-PCK</i>	1	-	527 004 280	52,50	B	
Focus 200							
 	Filter set for Focus 200, ISO Coarse ≥ 70 % (G4), 2 pieces <i>FIL-FCS-CRS/G4-2PC-PCK</i>	1	-	527 004 260	46,10	B	
	Pollen filter set for Focus 200, ISO Coarse ≥ 70% ISO ePM1 ≥ 60 % (G4 / F7), 2 pieces <i>FIL-FCS-CCP-CRS/G4-ePM1/F7-2PC-PCK</i>	1	-	527 003 430	51,10	B	
	Filter set for Focus 200, ISO Coarse ≥ 60 % 10 pieces <i>FIL-FCS-CCP-ePM1/F7-10PC-PCK</i>	1	-	527 009 750	229,10	B	

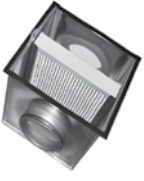















Replacement filters for ventilation units

Product	Description	PU 1	PU 2	Article no.	Gross price €	Discount group
Novus 300 / 450						
	 Filter set for Novus 300 / 450, ISO Coarse ≥ 70 % (G4), 2 pieces <i>FIL-NOV-CRS/G4-2PC-PCK</i>	1	-	527 004 250	53,10	B
	 Pollen filter set for Novus 300 / 450, ISO Coarse ≥ 70 % / ISO ePM10 ≥ 60 % (G4 / F7) 2 pieces <i>FIL-NOV-CRS/G4-ePM1/F7-2PC-PCK</i>	1	-	527 003 440	61,40	B
	 Filter set for Novus 300 / 450, ISO ePM10 60 % (F7) 10 pieces <i>FIL-NOV-ePM1/F7-10PC-PCK</i>	1	-	527 009 740	250,70	B
ComfoAir G 90 / 91 / Santos 250						
	 Filter set for ComfoAir G 90 / 91, G3 (filter pad) 2 pieces <i>FIL-L198-H465-<WK40/01-2pc</i>	1	25	006 040 104	9,50	B
	 Filter set for ComfoAir G 90 / 91, Santos 250, G3 (bag filter), 2 pieces <i>FIL-MFR-L198-H465->WK40/01-2pc</i>	1	25	006 040 102	28,20	B
	 Filter set for ComfoAir 500 / 350, G3 (filter pad) 2 pieces <i>FIL-L500-H198-G3-2pc</i>	1	25	006 040 120	28,20	B
ComfoAir 350 / 550, Santos 370 / 570						
	 Filter set for ComfoAir 350 / 550, Santos 370 / 570, ISO Coarse ≥ 60 % (G4) 2 pieces <i>FIL-PFR-L500-W16.5-H197-SEL-CRS-2pc</i>	1	-	400 100 085	54,50	B
	 Pollen filter set for ComfoAir 350 / 550, Santos 370 / 570, ISO Coarse ≥ 60 % / ISO ePM1 ≥ 50 % (G4 / F7) 2 pieces <i>FIL-PFR-L500-W16.5-H197-SEL-CRS/ePM1</i>	1	-	400 100 084	57,70	B
	 25 sets of filters coarse/ G4+ePM1/ F7 in 1 box, suitable for ComfoAir 350-450-550, ComfoD 350-450-550, ComfoFond-L ECO, box consists of 50 filters without manual <i>FIL-CA350/450/550-SET-CRS/ePM1-PBG-25PCS</i>	1	-	400 100 116	1.126,10	B
ComfoAir Q350 / 450 / 600						
	 Filter set for ComfoAir Q350/450/600, ISO Coarse ≥ 65 % (G4), 2 pieces <i>FIL-CAQ-CRS-2PC</i>	1	-	400 502 012	50,40	B
	 Pollen filter set for ComfoAir Q350/450/600, ISO Coarse ≥ 65 % / ISO ePM1 ≥ 55 % (G4 / F7) 2 pieces <i>FIL-CAQ-ePM1 / CRS</i>	1	-	400 502 013	54,50	B
	 Filter set for ComfoAir Q350/450/600, ISO Coarse ≥ 65 % / Active coal ePM10, 2 pieces <i>FIL-CAQ-1PC-AC-EPM10-1PC-CRS-PCK</i>	1	-	400 100 097	56,50	B
	 Filter set for ComfoAir Q350/450/600, ISO Coarse ≥ 65 % (G4), 10 pieces <i>FIL-CAQ-CRS-10PC</i>	1	-	400 502 014	225,60	B
	 Pollen filter set for ComfoAir Q350/450/600, ISO Coarse ≥ 65 % / ISO ePM1 ≥ 55 % (G4 / F7) 10 pieces <i>FIL-CAQ-ePM1-10PC</i>	1	-	400 502 015	264,20	B
	30 sets of filters Coars/ G4 + epm1/ F7 in 1 box suitable for ComfoAir Q and ComfoAir E, box consists of 60 filters with manual <i>FIL-CAQ-SET-CRS/CRS-PBG-30PCS</i>	1	-	400 100 118	1.061,70	B

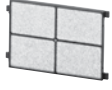
Replacement filters for ventilation units, outdoor air intake, filter box							
Product	Description	PU 1	PU 2	Article no.	Gross price €	Discount group	
ComfoAir Flex 250 / 350							
		Filter set for ComfoAir Flex 250 / 350 ISO Coarse ≥ 65 % / ISO ePM1 ≥ 65 % (G4 / F7) <i>FIL-CAF-ePM1/CRS</i>	1	-	400 100 121	60,00	C
		Filter set for ComfoAir Flex 250 / 350, ISO Coarse ≥ 65 % (G4), 2 pieces <i>FIL-CAF-CRS-2PC</i>	1	-	400 100 122	56,00	C
		Filter set for ComfoAir Flex 250 / 350, ISO Coarse ≥ 65 % / ISO ePM1 ≥ 65 % (G4 / F7), 5 pieces <i>FIL-CAF-ePM1-CRS-5PC</i>	1	-	400 100 123	278,00	C
		Filter set for ComfoAir Flex 250 / 350 ISO ePM1 ≥ 65 % (F7), 10 pieces <i>FIL-CAF-ePM1-10PC</i>	1	-	400 100 124	307,00	C
		Filter set for ComfoAir Flex 250 / 350 ISO Coarse ≥ 65 % (G4), 10 pieces <i>FIL-CAF-CRS-10PC</i>	1	-	400 100 125	257,00	C
Compakt 350							
		Filter for Compakt 350 extract air, ISO Coarse ≥ 55 % (G4), 1 piece <i>FIL-ATM-THM-FB-EPP-DN160-CRS/G4-1PC</i>	1	-	524 000 100	25,20	B
Air intake tower 300							
		Replacement filter for air intake tower 300, ISO Coarse ≥ 55% (G4), 1 piece <i>FIL-ATM-THM-FB-EPP-DN160-CRS/G4-1PC</i>	1	-	524 000 100	25,20	B
		Pollen filter for air intake tower 300, ISO ePM10 ≥ 60% (F7), 1 piece <i>FIL-ATM-THM-FB-EPP-DN160-ePM10/F7-1PC</i>	1	-	524 000 090	29,50	B
Iso filter box DN 125							
		Filter for iso filter box DN 125, ISO Coarse ≥ 75% (M5), 1 piece <i>FIL-CLI200-FB-EPP-DN125-CRS/M5-1PC-PCK</i>	1	-	521 013 080	24,70	B
		Pollen filter for iso filter box DN 125, ISO ePM1 ≥ 60% (F7), 1 piece <i>FIL-CLI200-FB-EPP-DN125-ePM1/F7-1PC-PCK</i>	1	-	521 012 720	28,00	B
		Active carbon filter for iso filter box DN 125, type AK, 1 piece <i>FIL-FB-EPP-DN125-AC-1PC</i>	1	-	521 014 090	49,10	B

Replacement filters for filter box

Product	Description	PU 1	PU 2	Article no.	Gross price €	Discount group	
Pollen filter housing DN 150 / 160							
 	Pollen filter for pollen filter housing DN 150 / 160, F7 dimensions 287 x 287 x 44 mm 1 piece <i>FIL-F7-L287-W44-H287</i>	1	-	990 316 102	67,00	B	
Filter box DN 160							
		Filter for filter box DN 160, ISO Coarse ≥ 70% (G3) 1 piece <i>FIL-FB-PRH-EPP-DN160-CRS/G3-1PC</i>	1	-	524 000 810	25,20	B
		Filter for filter box DN 160, ISO Coarse ≥ 55% (G4) 1 piece <i>FIL-ATM-THM-FB-EPP-DN160-CRS/G4-1PC</i>	1	-	524 000 100	25,20	B
		Pollen filter for filter box DN 160, ISO ePM10 ≥ 60% (F7) 1 piece <i>FIL-ATM-THM-FB-EPP-DN160-ePM10/F7-1PC</i>	1	-	524 000 090	29,50	B
		Active carbon filter for filter box DN 160, type AL (smoke, flue gases) 1 piece <i>FIL-FB-EPP-DN160-AC/K-1PC</i>	1	-	524 000 080	78,20	B
Pollen filter housing DN 180							
 	Pollen filter for pollen filter housing DN 180, F7 dimensions 287 x 287 x 94 mm 1 piece <i>FIL-F7-L287-W94-H287</i>	1	24	990 316 103	97,60	B	

Replacement filters for heating elements, brine-earth heat exchangers, air distribution								
Product	Description	PU 1	PU 2	Article no.	Gross price €	Discount group		
Iso defroster box DN 160								
	 Filter for iso defroster DN 160, ISO Coarse ≥ 70% (G3) 1 piece <i>FIL-FB-PRH-EPP-DN160-CRS/G3-1PC</i>	1	-	524 000 810	25,20	B		
ComfoFond-L 300 / 600								
	 Filter for ComfoFond-L 300 / 600, G4 dimensions: 287 x 287 x 48 mm 1 piece <i>FIL-PFR-L287-W27-H48-CRS-PBG</i>	1	24	400 100 060	80,50	B		
ComfoFond-L Eco 350 / 550								
	 Filter for ComfoFond-L Eco 350 / 550, ISO Coarse ≥ 60 % (G4), 1 piece suitable for ComfoFond-L Eco 471310012, 471310017, 471310022, 471310027, 471310070, 471310071, 471310080 and 471310081 <i>FIL-PFR-L500-H197-CRS-PCK</i>	1	-	400 100 065	28,00	B		
	 Filter for ComfoFond-L Eco 350 / 550 and ComfoFond-L Q, ISO Coarse ≥ 60 % (G4) 1 piece suitable for ComfoFond-L Eco 471310013, 471310018, 471310023, 471310028 and ComfoFond-L Q <i>FIL-CRS-SPR-P</i>	1	-	400 100 066	28,00	B		
Air distribution								
	 Replacement filter for extract air housing 990 220 010, ISO Coarse ≥ 45 % (G3) 10 pieces <i>FIL-CLD-L230-W110-CRS-45%-10PC</i>	1	10	990 320 030	28,00	B		
	 Replacement filter for extract air housing CLD, ISO Coarse ≥ 45 % (G3) 10 pieces <i>FIL-CLD-L158-W113-H9-CRS-45%-10PC-WHITE</i>	1	540	990 320 575	87,30	B		
		Filter set DN 100, ISO Coarse ≥ 45 % (G3) suitable for Luna E125, extract valves and designer grilles 10 pieces <i>FIL-DIV-DN100-CRS-45%-10PC</i>		1	20	990 320 031	29,30	B
		Filter set DN 125, ISO Coarse ≥ 45 % (G3) suitable for extract air valves and designer grilles CLRf / TVA 10 pieces <i>FIL-DIV-DN125-CRS-45%-10PC</i>		1	20	990 320 032	32,30	B
	 Filter set CLF, ISO Coarse ≥ 30 % 10 pieces <i>FIL-CLF-L295-W75-CRS-30%-10PC</i>	1	70	990 322 100	76,20	B		

Replacement filters for ComfoWell

Product	Description	PU 1	PU 2	Article no.	Gross price €	Discount group
	Fine dust filters and active carbon filters for installing in filter housing					
	Fine dust filter CW 220-PM1-90% dimensions: 200 x 225 x 48 (L x W x D), filter ISO ePM1 ≥ 90 % (F9) <i>FIL-CW220-PM1-90%</i>	1	108	990 323 601	57,00	B
	Fine dust filter CW 320-PM1-90% dimensions: 300 x 225 x 48 (L x W x D), filter ISO ePM1 ≥ 90 % (F9) <i>FIL-CW320-PM1-90%</i>	1	72	990 323 604	64,60	B
	Fine dust filter CW 420-PM1-90% dimensions: 2 pieces, each 200 x 225 x 48 (L x W x D), filter ISO ePM1 ≥ 90 % (F9) <i>FIL-CW420-PM1-90%</i>	1	-	990 323 651	84,90	B
	Fine dust filter CW 520-PM1-90% dimensions: 500 x 225 x 48 (L x W x D), filter ISO ePM1 ≥ 90 % (F9) <i>FIL-CW520-PM1-90%</i>	1	48	990 323 607	86,80	B
	Fine dust filter CW 625-PM1-90% dimensions: 2 pieces, each 300 x 225 x 48 (L x W x D), filter ISO ePM1 ≥ 90 % (F9) <i>FIL-CW625-PM1-90%</i>	1	-	990 323 654	106,30	B
	Active carbon filter CW-FC 220 dimensions: 200 x 225 x 96 (L x W x D) <i>FIL-CW220-AC</i>	1	54	990 323 602	43,20	B
	Active carbon filter CW-FC 320 dimensions: 300 x 225 x 96 (L x W x D) <i>FIL-CW320-AC</i>	1	36	990 323 605	50,20	B
	Active carbon filter CW-FC 420 dimensions: 2 pieces, each 200 x 225 x 96 (L x W x D) <i>FIL-CW420-AC</i>	1	-	990 323 652	61,50	B
	Active carbon filter CW-FC 520 dimensions: 500 x 225 x 96 (L x W x D) <i>FIL-CW520-AC</i>	1	24	990 323 608	72,80	B
	Active carbon filter CW-FC 625 dimensions: 2 pieces, each 300 x 225 x 96 (L x W x D) <i>FIL-CW625-AC</i>	1	6	990 323 655	84,40	B

Notes

A large grid of small dots for taking notes, covering most of the page.

always the best climate

Zehnder Baltics OÜ

Rannamõisa tee 38d ■ 13516 Tallinn ■ Estonia

+372 6840 937 ■ info.baltics@zehndergroup.com ■ www.zehnder.ee ■ www.zehnder.lv ■ www.zehnder.it